

YUME

Operating Instructions

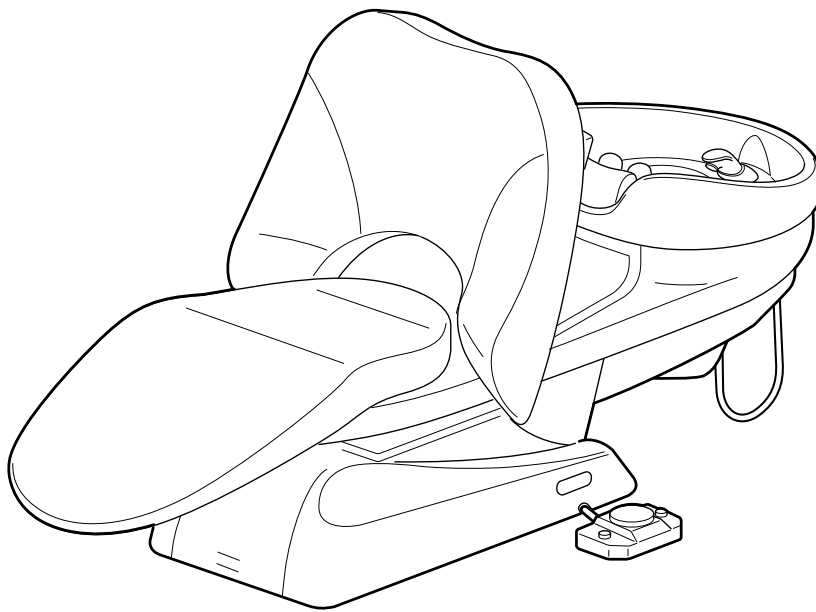

Thank you for purchasing our Takara Belmont YUME.

The instructions contained in this booklet should be thoroughly read and understood before operating the shampoo unit.

This product is intended for the exclusive use for hairdressing & barber salons, and must not be used for other purpose.

Keep manual in a place where it can be easily referred to when necessary.

 **TAKARA
BELMONT**

BEGB37A0

TABLE OF CONTENTS

1. Locations of Warning Labels	1
2. Dimension and Specifications	2
3. Overall View and Major Components.....	3
4. Accessories	4
5. Preparation	4
6. Operating Instruction.....	5
7. Maintenance	8
8. Troubleshooting.....	10
9. Consumable Parts.....	10

1. Locations of Warning Labels

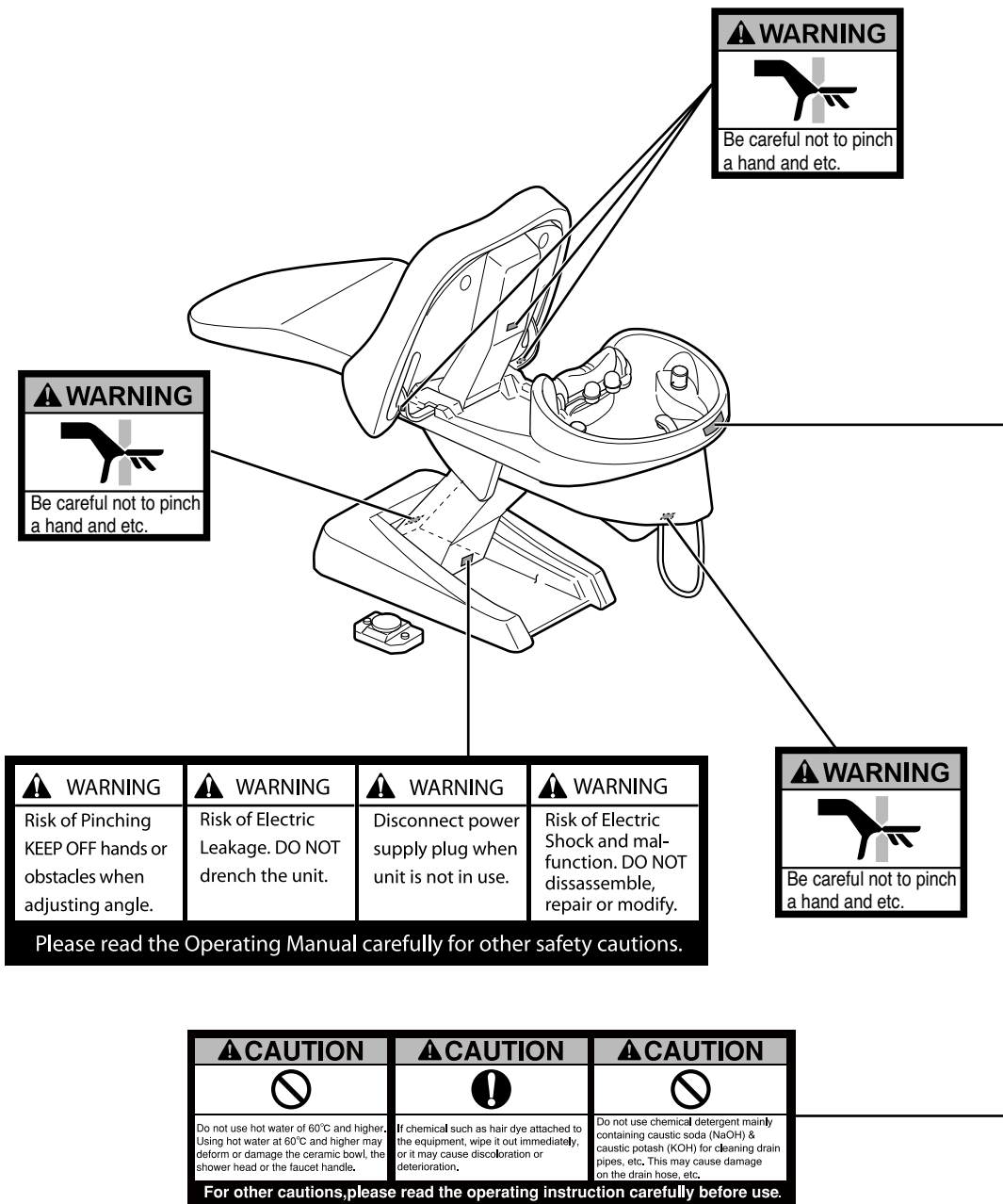

2. Dimension and Specifications

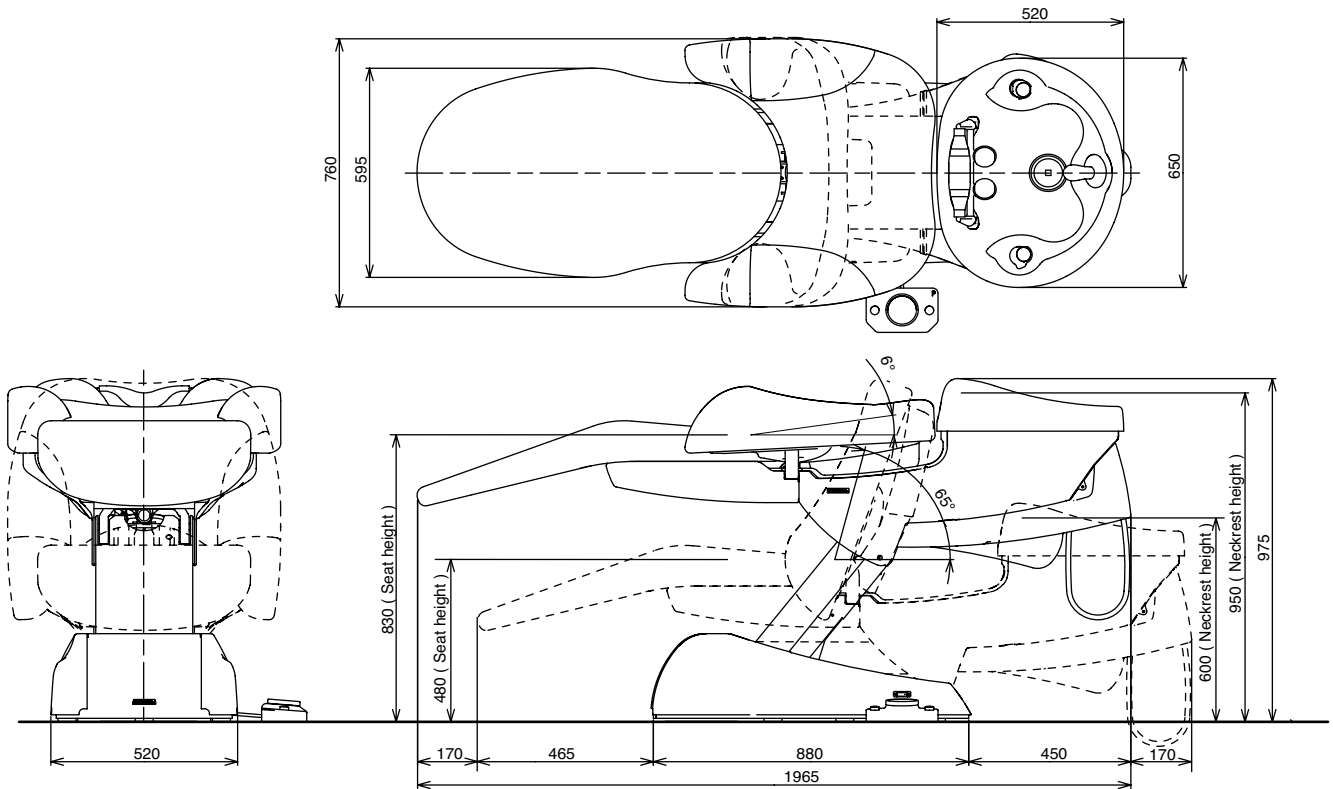

- Type ----- EX-YML, EX-YMR, SU-YM
- Drive System ----- Motorized Hydraulic System
- Measurement ----- 760 x 1985 x 975 mm (W x L x H)
- Angle of Bracket ----- 59° (6° ~ 65°)
- Type of Mixing ----- Thermo Mixing
- Stop Valve ----- Water x 1 (Handle Type) / Hot Water x 1 (Handle Type)
- Electrical Requirements ----- AC120V 50/60Hz 5.8/4.4A
AC220V 50/60Hz 2.1/2.5A
AC230V 50/60Hz 2.1/2.4A
AC240V 50/60Hz 2.3/2.3A
- Usage Environment ----- Operational Temperature (10 ~ 40°C)
- Water and Hot Water ----- 0.08 ~ 0.6Mpa (0.8 ~ 6kgf/cm²)
- Supply Pressure ----- Water Supply Pressure ≥ Hot Water Supply Pressure
Pressure difference between water supply and hot water supply within 0.2Mpa (2kgf/cm²)
- Water Volume (Shower Head) ---- 10 l /min (water and hot water pressure are 0.1 Mpa)
- Weight ----- 156 kg

3. Overall View and Major Components

■ Body

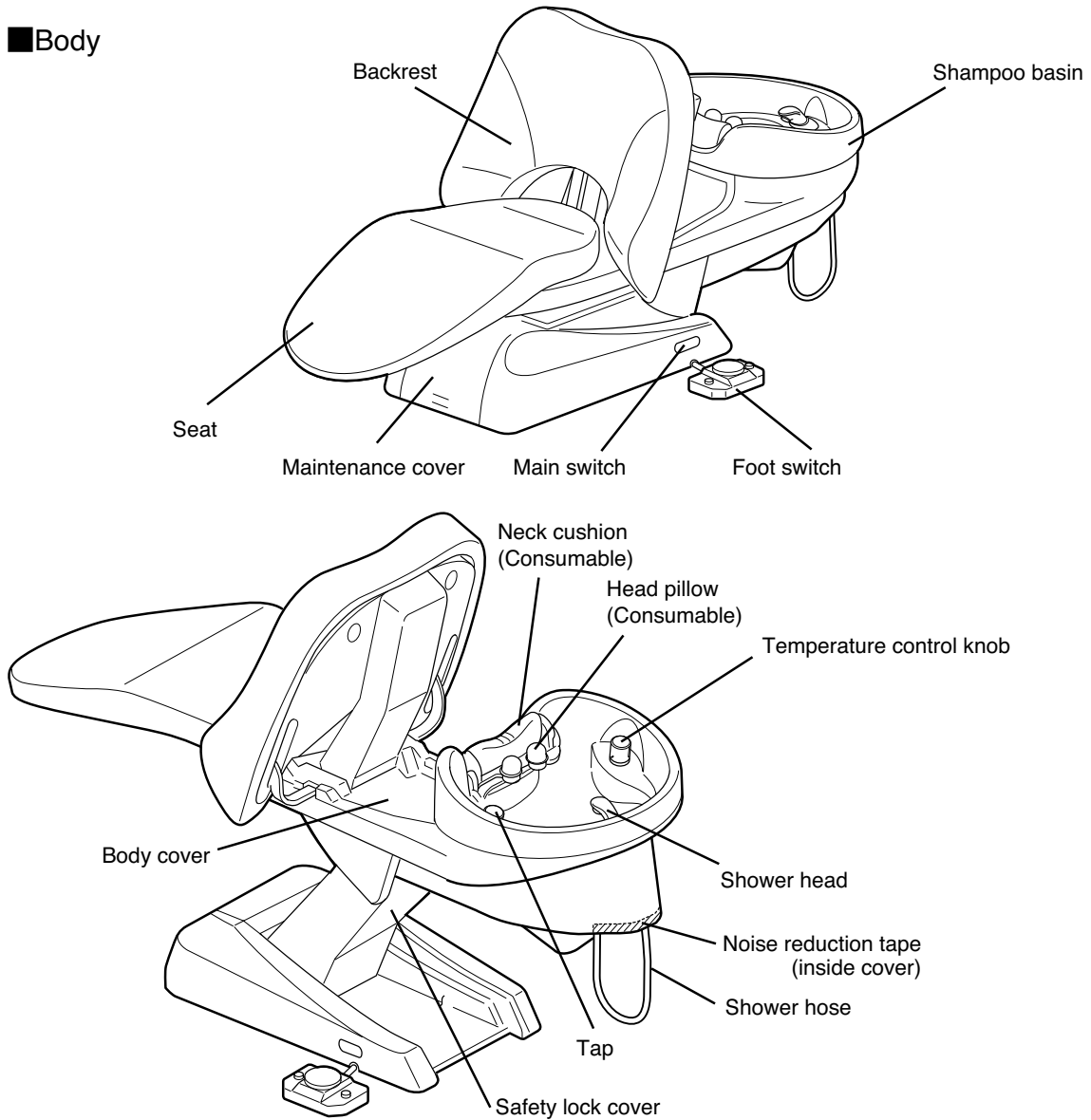

■ Foot switch

EX-YML : left side foot switch

EX-YMR : right side foot switch

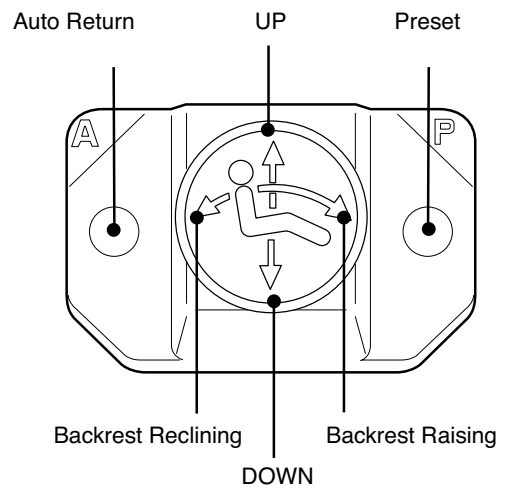
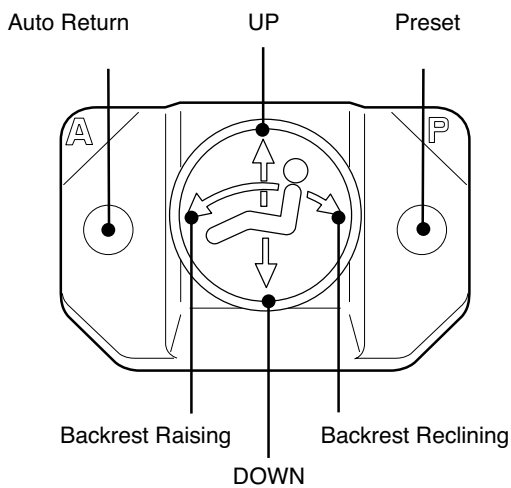

4. Accessories

· Neck Cushion ...1

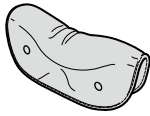

· Head Pillow ...1set

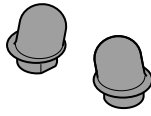

· Noise Reduction Tape ...1

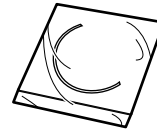

· Drain Cap ...1

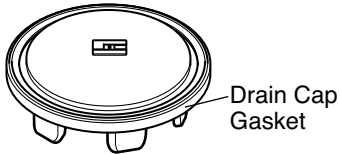

· Strainer ...1



· Operation Manual ...1

5. Preparation

5-1. Attach the Neck Cushion

1. Attach the neck cushion on metal fittings as shown in figure.

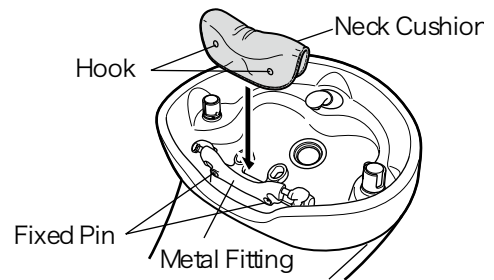

2. Both side hooks of the neck cushion is fixed on a fixed pin.

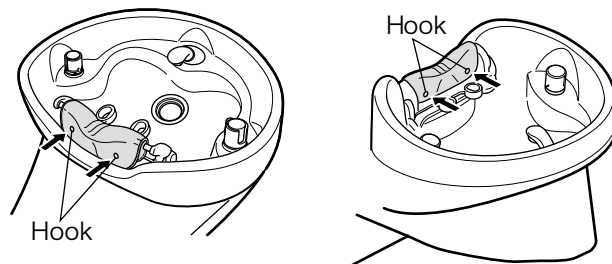

5-2. Attach the Head Pillow

1. Attach the head pillow as shown in figure.

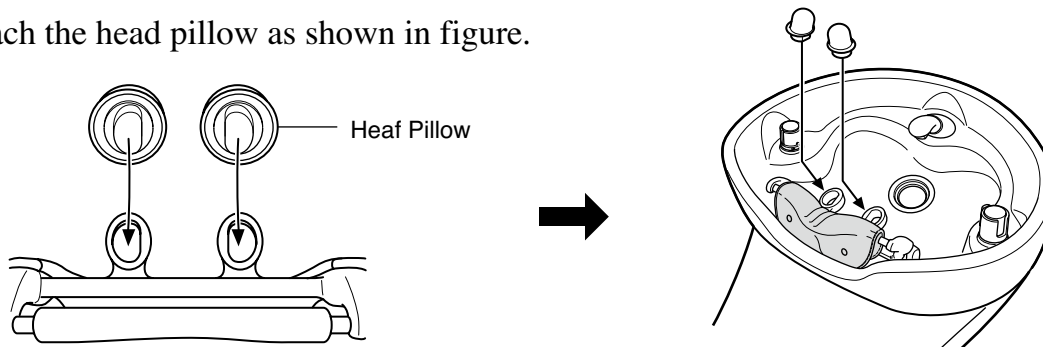

6. Operating Instruction

6-1 Main Switch

Turn on the main switch of EX-YML located on the left side of the pump cover and that of EX-YMR located on the right side of the pump cover.

Caution

- Turn off the main switch after daily operation
- Operate the main switch by hand only.

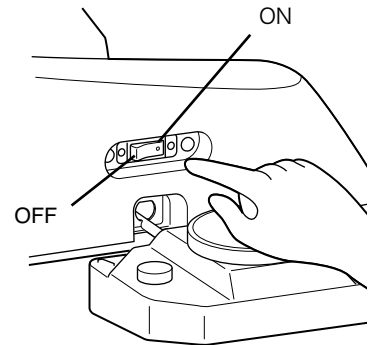

6-2 Controls

Before operating the chair, confirm that it is safe for the patient and the operator.

(1) Manual Mode Control

A. Seat Lifting

Keep depressing UP button until the seat is lifted up to the desired position.

B. Seat Lowering

Keep depressing DOWN button until the seat is lowered to the desired position.

C. Backrest Reclining

Keep depressing Backrest reclining button until the backrest is reclined to the desired position.

D. Backrest Raising

Keep depressing Backrest raising button until the backrest is raised to the desired position.

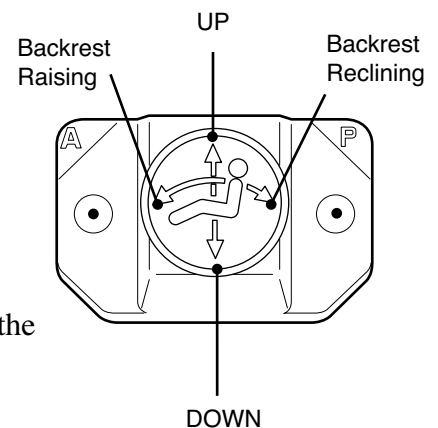

(2) Auto Mode Control

E. Preset Control

Momentarily depress Preset button on the foot control, the chair will move to the preset position automatically. (Preset position is set best position of seating shampoo. If adjustment is needed, please refer AUTO MODE POSITION ADJUSTMENT.

F. Auto Return

Momentarily depress Auto return button on the foot control, the chair will return to the initial position. (The seat is fully lowered and the backrest is in the upright position.)

G. Emergency Stop

During automatic procedure (Preset and Auto return), depress of any side of the buttons on the foot control will cancel the automatic movement immediately.

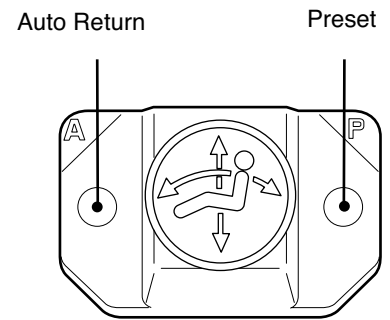

6-3 Auto Mode Position Adjustment

Preset position adjustment

- A. Set the seat and the backrest to the desired preset position by manual control.
- B. Turn off main switch.
- C. While depressing Preset button, turn on main switch.
- D. Keep depressing Preset button until buzzer sounds, then release it.

6-4. SAFETY LOCK DEVICE

Chair down movements can be stopped automatically by the safety lock device when pressure is detected between the base and the safety lock cover.

If the safety device has been activated, simply operate the base up button and remove the object causing the safety device to activate from this area.

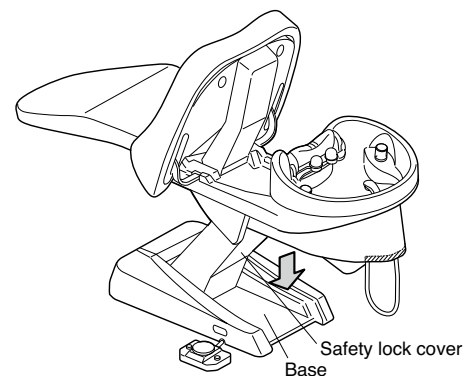

6-5 Adjustment the Water / Hot Water

- A. Turn the tap to counter clockwise.
- B. Adjust the water temperature with temperature control knob.
- C. Press stop button on the temperature control knob to release lock for hot water, then turn clockwise.

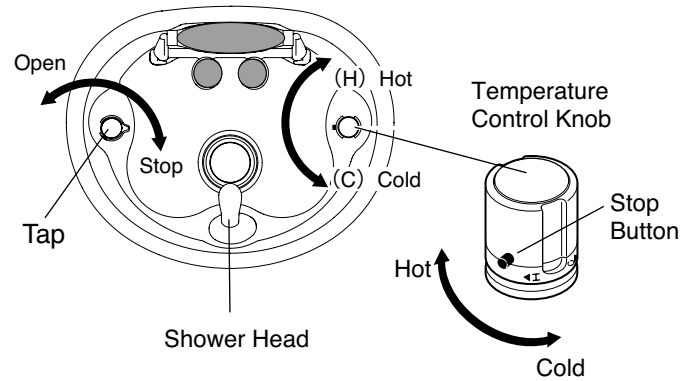

6-6 How to keep the Water / Hot Water in the Shampoo Basin

Turn the drain cap upside down.

⚠ Caution

Do not raise or lower the chair while keeping the water / hot water in the shampoo basin.

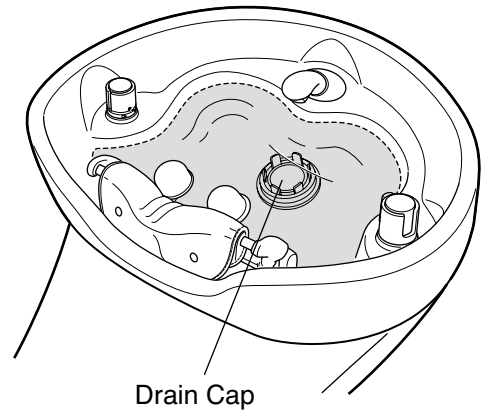

7. Maintenance

Notice

Do not use the following substances.

Thinner, alcohol, gasoline, kerosene or other volatile chemicals; waxes containing abrasives; sponges containing abrasives, etc.

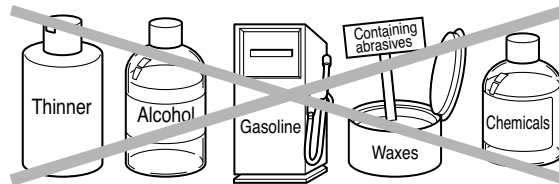

7-1. Strainer

Take out the strainer under the drain cap and remove hairs from the strainer.

Caution

Clean the hair trap as often as possible. If using the hair trap not cleaned, it may cause clogging of the port, overflow or poor sanitary. Cleaning the hair trap every after each shampooing is recommended.

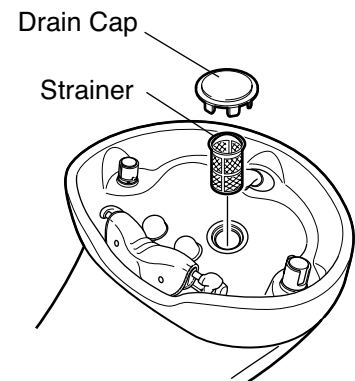

7-2. Neck cushion and head pillow(consumable parts)

Use dry cloth to wipe off water and dry in shade.

Dump cloth with neutral detergent and wipe to remove coloring or perm solution.

Caution

Rinse the cushion immediately after chemical is splashed on the neck cushion. Splashed chemical may cause deterioration or discoloration.

7-3. Use dry and soft cloth to clean upholstery, plastics, plated and painted surface.

Dump cloth with neutral detergent and wipe to remove stubborn stains and dirt. Use only mild neutral detergent. Use cotton buds etc. to clean around the neck cushion and head pillow mounting parts.

7-4. Drain cap gasket (consumable part)

Remove hairs and coloring or perm solutions by washing drain cap in water. Take drain cap gasket out and was in water with neutral detergent. After washing, remove the neutral detergent completely. Do not attach drain cap gasket up side down.

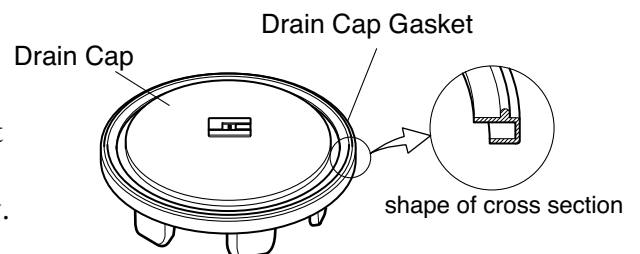

7-5. Cleaning of bowl

Wipe the bowl with diluted neutral detergent.

Caution

Do NOT use metal scrub brushes, paper files. Using them may be a cause of scars.

7-6. Strainer for check valve

Clean strainer (built-in check valve) at regular intervals.

Remove the water in strainer if freezing is expected in the cold district.

A. Raise the chair and turn off the main switch.

B. Remove 2 screws and open the maintenance cover

C. Place cloths near the water / hot water supplise.

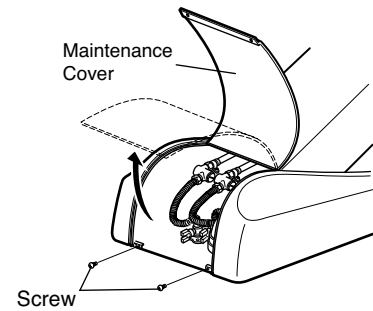

D. Turn off the water & hot water stop valves and remove strainer by flat head screw driver and wipe off the water by cloth.

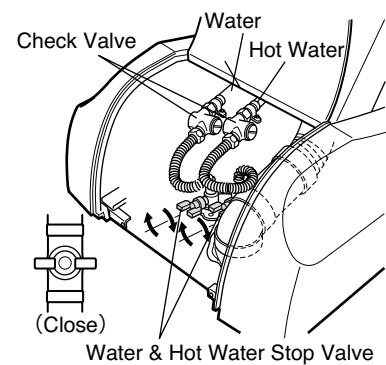

E. After cleaning the strainer, put it back and tighten up.

F. Wipe water off and remove cloth.

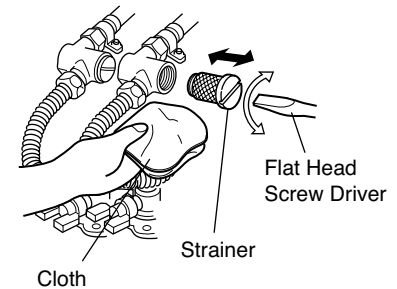

G. Turn on the water / hot water shut off valves.

H. Close the maintenance cover and install 2 screws.

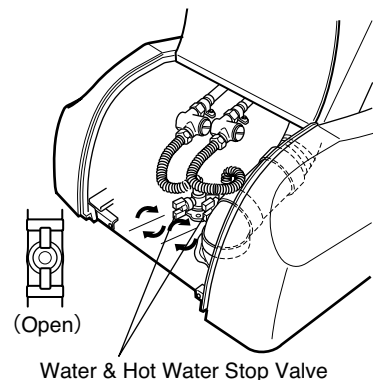

Water leak check

Open the maintenance cover and check water leakage once a month.

8. Troubleshooting

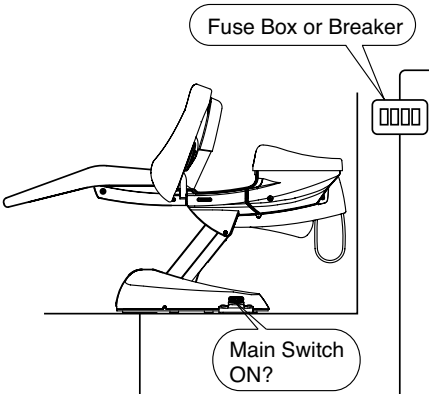
Symptom	Check
<ul style="list-style-type: none"> ● Seat and backrest doesn't move 	<ul style="list-style-type: none"> ○ Make sure that the power plug is properly plugged into the outlet. ○ Make sure that the main switch has been turned on.
	<ul style="list-style-type: none"> ○ Check the fuses in your fuse box to make sure they haven't burned out. If you have a breaker box, check for tripped breakers. ○ After the long time operation, Over temperature protection system works. Please leave the chair for 10 minutes and start operation. Unplug the machine and then plug it in again and see if it will operate.
<ul style="list-style-type: none"> ● No Water / Hot Water 	<ul style="list-style-type: none"> ○ Make sure that the water / hot water shut off valve has been turned on.
<ul style="list-style-type: none"> ● The temperature of hot water is too low 	<ul style="list-style-type: none"> ○ Check to make sure that the temperature setting of water supply tank is properly. ○ Make sure that the temperature setting of the chair is properly.
<ul style="list-style-type: none"> ● Slow drainage 	<ul style="list-style-type: none"> ○ Check to make sure that the hair removed from the hair catcher completely.

In case other than those listed above, contact our service center or sales office.

CAUTION

If the supply cord is damaged, it must be replaced by the manufacturer or its service agent or similarly qualified person in order to avoid hazard.

9. Consumable Parts

- Neck cushion
- Head pillows
- Drain cap gasket

NOTE



TAKARA BELMONT CORPORATION
1-1, 2-Chome, Higashi-shinsaibashi, Chuo-ku, Osaka, Japan
TEL : (06) 6213-5945 FAX : (06) 6212-3680

Printed in Japan