

















PARAGON® ESTHETICIAN'S TROLLEY - MODEL NO. H-8

(A) 1 PC 	(B) 1 PC 	(C) 1 PC 	(D) 2 PCS 	(E) 3 PCS 	(F) 1 PC 	(G) 4 PCS 
(H) 1 PCS 	(I) 6 PCS 	(J) 18 PCS Metal 	(K) 18 PCS Plastic 	(L) 1 PC 	(M) 1 PC 	(N) 1 PC 
(O) 2 PCS 	(P) 2 PCS 	(Q) 12 PCS 				

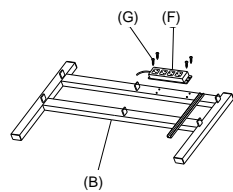

1 POWER STRIP

Using the screws (G), securely fasten power strip (F) to the pre-drilled holes on metal frame (B).

2 CASTER WHEELS

Insert roller caster wheels (H) into metal frames (A)+(B), and secure by tightening the nut with hand wrench tool (N).

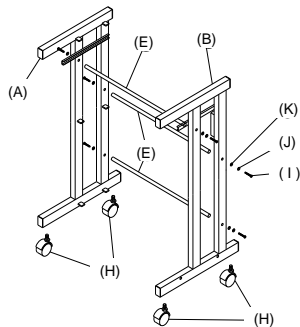

3 FRAME ASSEMBLY

Insert metal rods (E) into allotted holes in metal frames (A)+(B). Using tool (M) secure the rods to frame with plastic washer (K), metal washer (J), and bolt (I).

TIP: Leave bolts and screws a little loose to allow for adjustments in assembly. Once the trolley is complete, review these steps and securely fasten all joints, bolts, and screws.

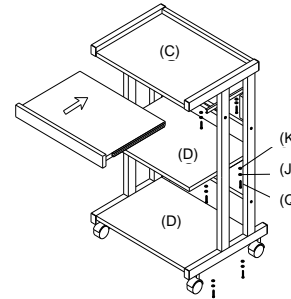

4 SHELVES & DRAWERS

Using tool (M) install shelf (C) and shelves (D) with plastic washer (K), metal washer (J), and bolt (Q).

TIP: To ease assembly with each shelf / drawer, assemble all screws and bolts loosely. Inserting one screw too tightly may cause difficulty in securing the additional screws.

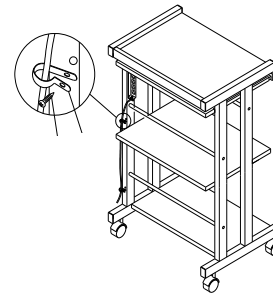

5 SECURING THE POWER CORD

Place power cord into plastic buckle (O). Using the screws (P), securely fasten plastic buckles (O) to the pre-drilled holes at the rear of metal frame.

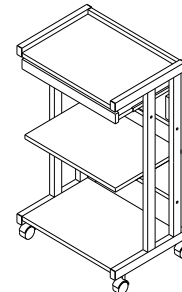

6 TIGHTEN ALL JOINTS

Review steps 1-5 and tighten all screws, bolts and joints.