

Thermalator™

Moist Heat Therapy Unit

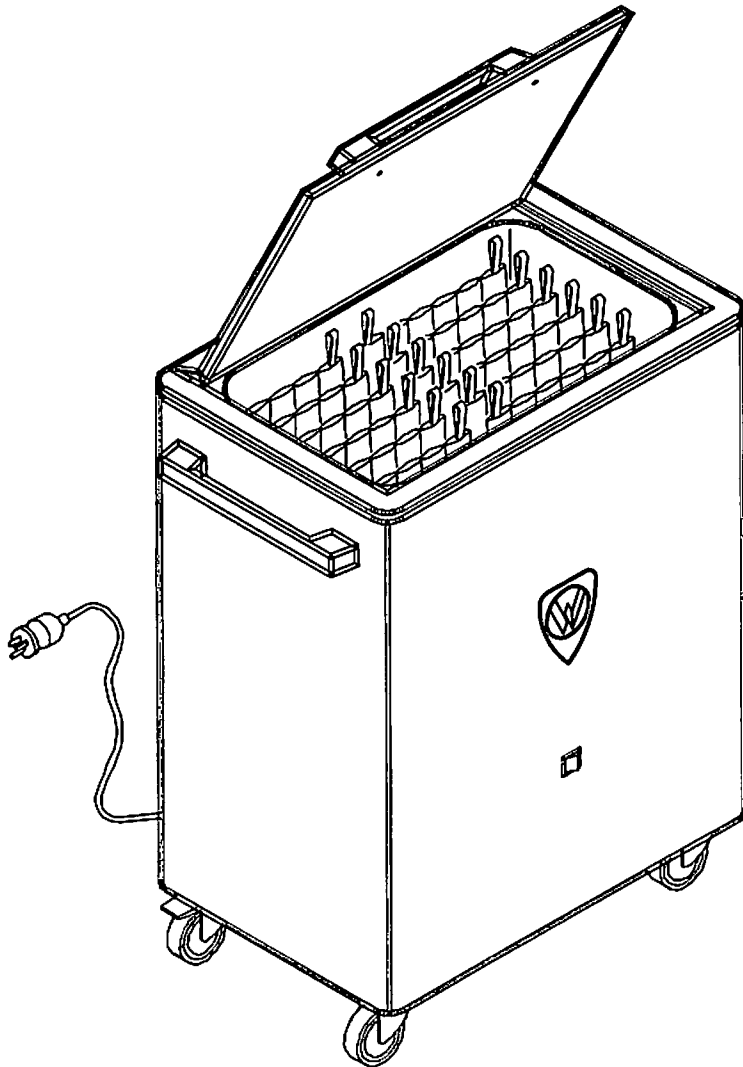

- Stationary 12 Pack
Thermalator
Model T-12-M
- Stationary 12 Pack
Thermalator, 220 Volt
Model T-12-M-V

Manufactured by:

 **Whitehall
Manufacturing**
A DIVISION OF ACORN ENGINEERING COMPANY
CITY OF INDUSTRY, CALIFORNIA

Operating Instructions

PLEASE

***Read this entire booklet before
operating your new Thermalator.***

If you have any questions, please contact us:



TOLL FREE: **800-782-7706**

LOCAL: **626-968-6681**

FAX: **626-855-4862**

E-MAIL: **info@whitehallmfg.com**

Whitehall Thermalator Operating Instructions

Stationary 12-Pack Thermalator

TABLE OF CONTENTS

USER HELP INFO	2
TABLE OF CONTENTS	3
GENERAL WARNINGS	4
DESCRIPTION	4
What are the parts?	5
SET UP INSTRUCTIONS	6-9
What's included?	6
Unpacking my Thermalator	6
Where do I put my Thermalator?	6
Pre-soaking Thermal Packs	6-7
Filling my unit	7-8
Emptying my unit	9
Before the first use	9
USING YOUR THERMALATOR	10-12
How do I use the Thermal Packs?	10
How do I use the colored tabs?	11
How do I change the temperature?	12
How do I use different size Thermal Packs?	12
CLEANING	13-15
What do I use?	13
Routine cleaning	13-14
Cleaning color coated surfaces	14-15
For scratches, stains	15
MAINTENANCE	16
STORAGE	16
TROUBLESHOOTING	17
TECHNICAL INFORMATION	18-21
Electrical information	18
Replacement parts (T-12-M)	18
Exploded view (T-12-M)	19
Replacement parts (T-12-M-V)	20
Exploded view (T-12-M-V)	21
ACCESSORIES	22-23
Thermal Pack Covers	22
Thermal Packs	22-23
Combination Sets	23



WARNING



- DO NOT reach into water to get the Thermal Packs. Skin burns may occur. Use the blue or white tabs or tongs.**
- DO NOT use unit near explosive gases. Fires may occur.**
- DO NOT place the Thermal Pack on bare skin. Skin burns may occur. Always place the Thermal Pack in a terry cover.**
- Remove ALL packaging before using.**
- Fill with water before you plug in the unit. If the unit is empty, the heating element will burn out.**
- Plug into a Ground Fault Circuit Interrupter (GFCI), a receptacle to protect you if water and electricity mix. Properly ground the Thermalator™. Failure may increase the risk of electric shock.**

DESCRIPTION

Your Thermalator™ is a simple and trouble-free unit to operate. The tank body, lid, bottom and tank housing are all made from type 304 stainless steel. The controls are an ON/OFF switch on the front of the unit and a thermostat on the rear to control the water temperature. It is preset to a normal operating temperature. A handle on the lid minimizes contact with the hot surface. The unit has Thermal Packs with blue and white tabs and stainless steel insert hangers that fit onto a stainless steel wire rack. Inside the unit is a heating element and temperature sensor. Side handles and locking casters below allow easy movement of the unit. A drain valve is located on the back of the unit.

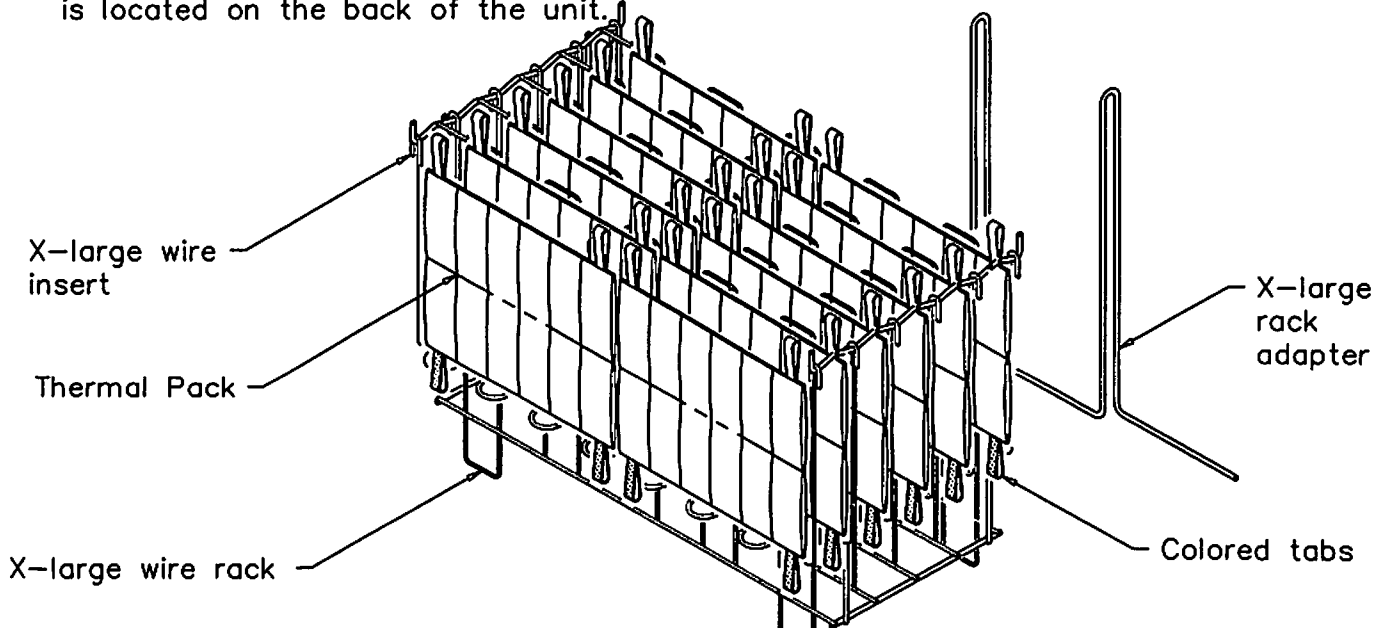

Thermalator™
Models T-12-M & T-12-M-V

FRONT VIEW

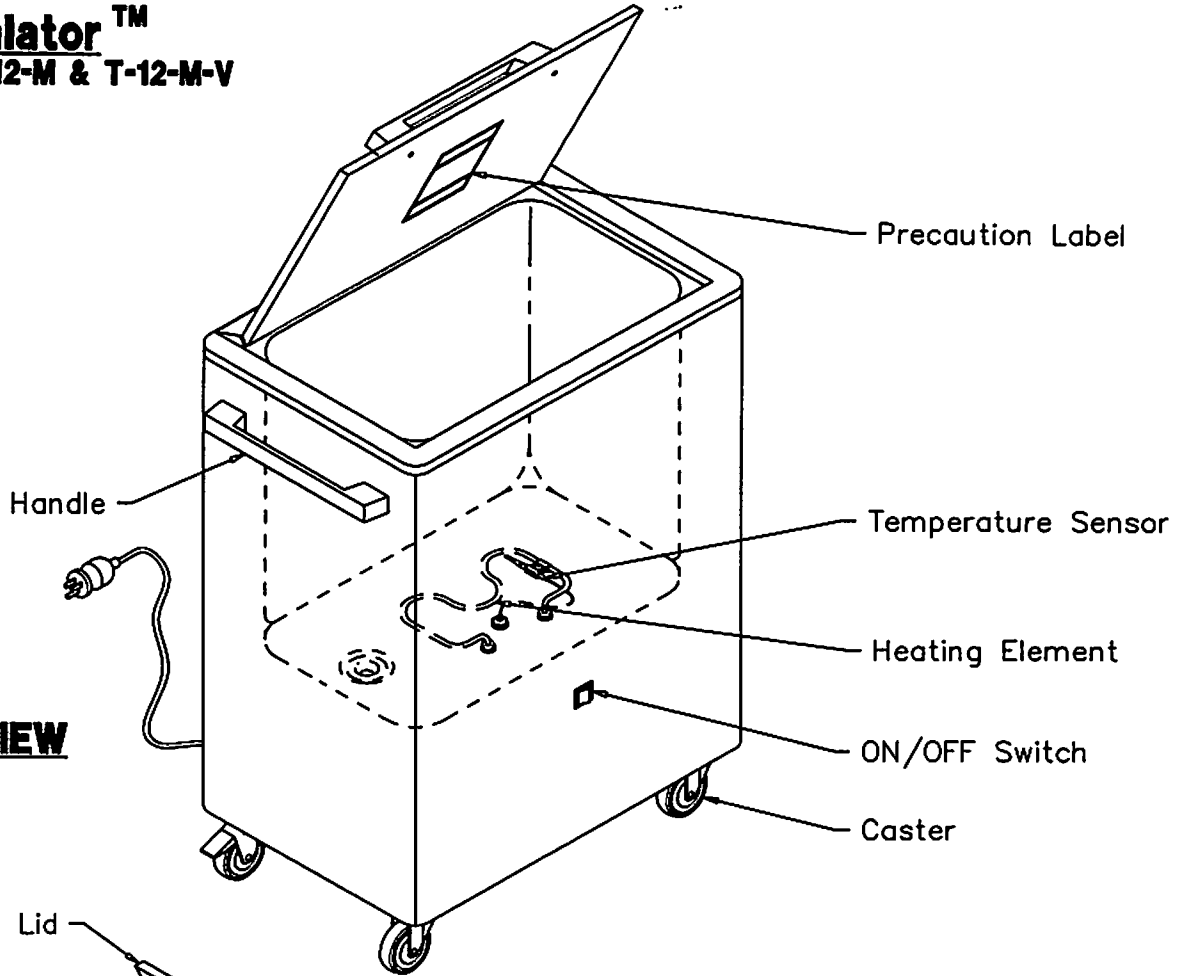

BACK VIEW

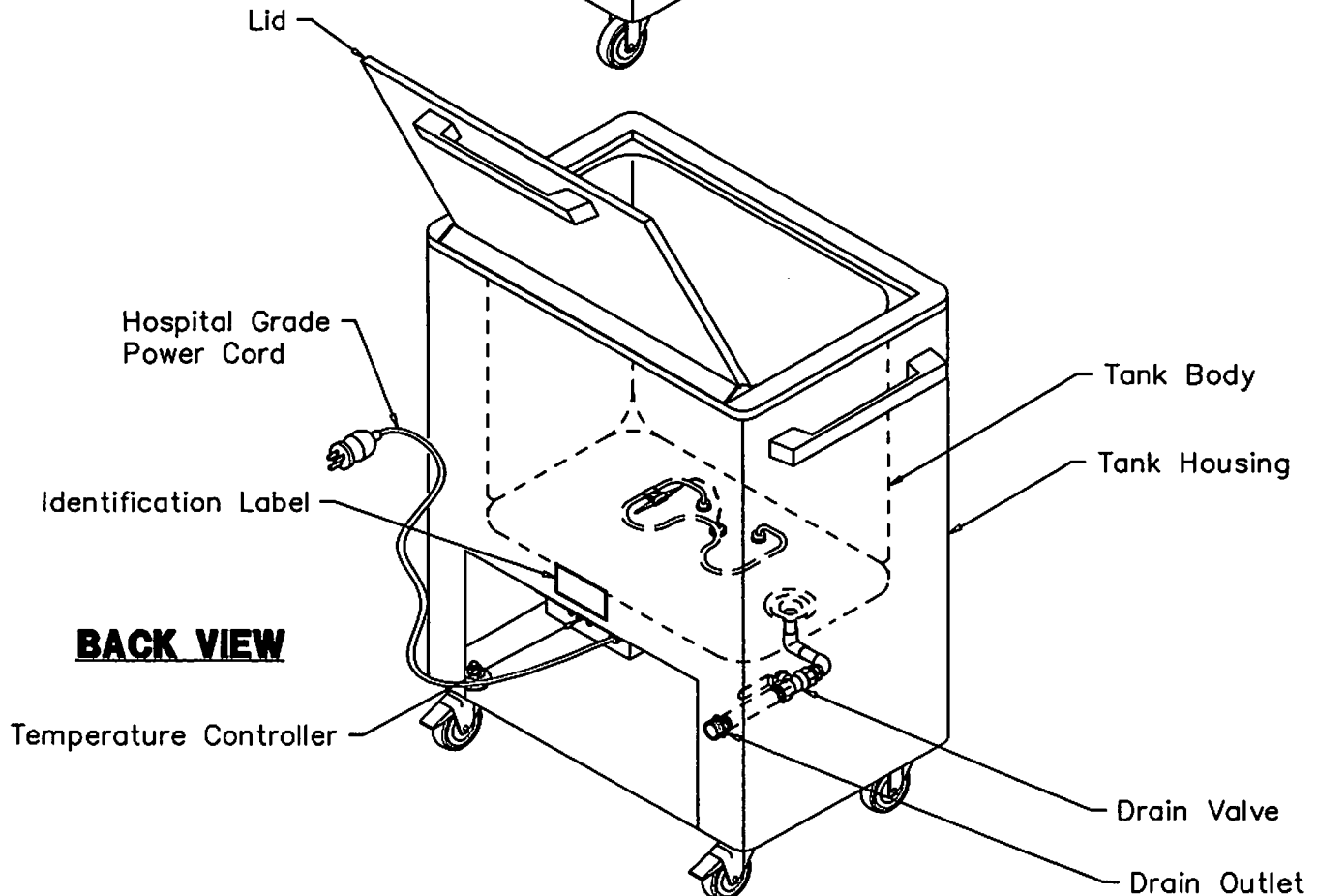

SETTING UP

1. Your new Thermalator™ includes the following:

- 1 Thermalator™ Model T-12-M or T-12-M-V
- 12 Thermal Packs (10" x 12") or alternates
- 1 Wire Rack - X-large (stainless steel)
- 6 Wire Inserts - X-large (stainless steel)
- 1 Rack Adapter - X-large (stainless steel)
- 1 Filler hose
- 1 Warranty Registration card
- 1 Operating Instructions Booklet

If you are missing anything, please call the phone number listed on the inside front cover.

2. Unpacking your Thermalator™

Remove all the shipping material. Remove Thermal Packs and wire rack from inside the tank. Remove all packaging from inside the tank, especially from under the heating element inside the tank. Clean the unit thoroughly before using.

3. Device Placement

Place the Thermalator™ in a convenient location, such as near the treatment area. Before moving your Thermalator™, unplug the unit. Only move the unit to empty or to fill it. Always use the handles. The top lid may be hot to the touch.

4. PRE-SOAKING Thermal Packs

Before the first use, you must condition each Thermal Pack. Soaking in water lets the pack swell to its full size. This is necessary only BEFORE the first use. You can then reuse the pack after about 15 minutes of reheating.

- 1-Take the Thermal Pack by the corner loops - one white and one blue - so the sections are horizontal.
- 2-Gently shake the pack back and forth to evenly distribute the filler material.

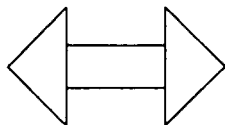

**Shake to
distribute
the dry
material**

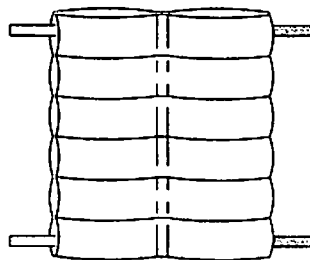

- 3-Place the Thermal Pack in a large metal (use stainless steel or enamel-ware, DO NOT use aluminum) or plastic container. You MAY USE the Thermalator™:

- *Place the Thermal Pack in the unit with sections horizontal.
- *Change the water after soaking; it will become cloudy.

- 4-Fill the container with enough tap water to completely cover the Thermal Packs.
- 5-Soak the packs for 1 hour minimum; 2 hours or more are recommended. Cloudy water after soaking is normal.
- 6-Return the packs to upright. The packs are now ready for heating.

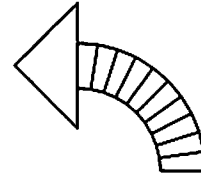
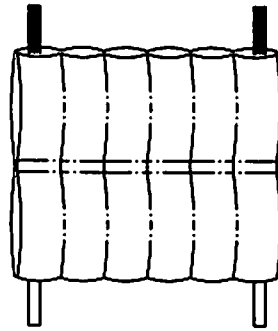

Turn the packs to upright

FILLING

- 1** Make sure the unit is unplugged and all packaging has been removed.

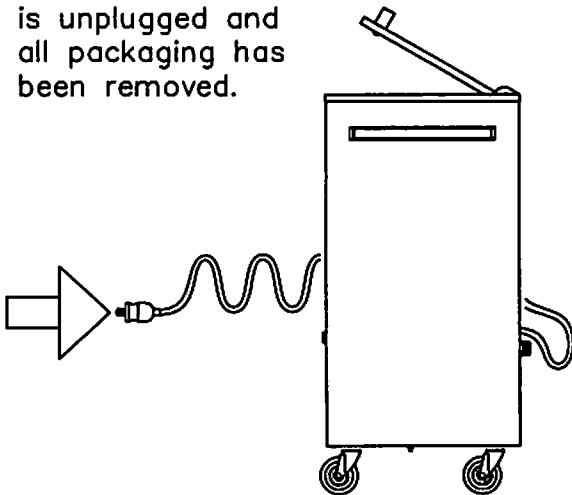

- 2** Check the drain valve before filling. Using the filler hose provided, fill the unit about 3/4 full with tap water.

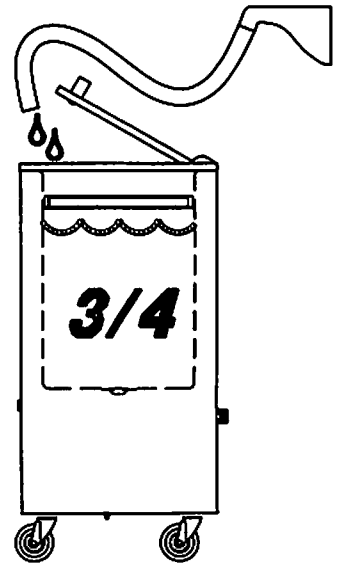

- 3** Place the wire rack inside the unit. Be careful of the heating element.

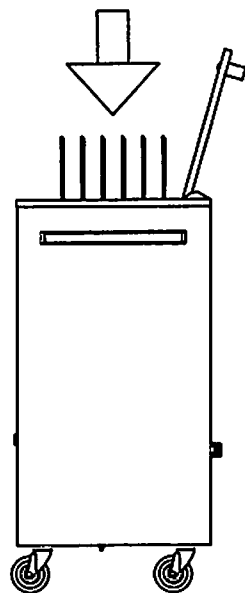

- 4** Put the PRE-SOAKED Thermal Packs on the wire rack. Place all the blue or white tabs up.

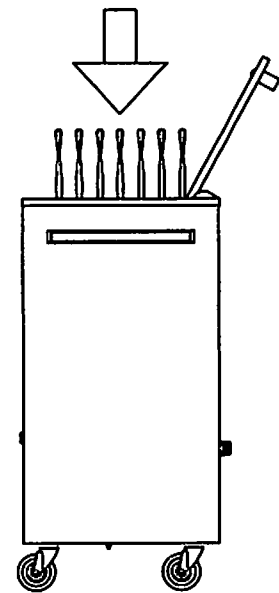

5 Add more water, if necessary, to cover the Thermal Packs. Uncovered packs may be damaged during heating.

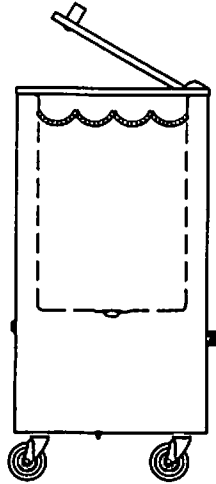

6 Close the lid.

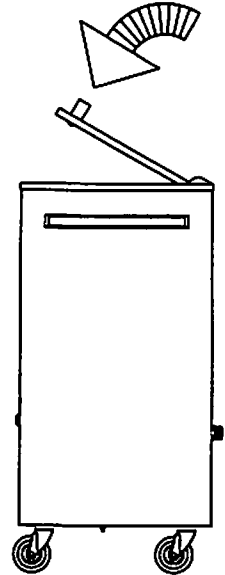

7 Plug the power cord into an AC outlet. A Ground Fault Circuit Interrupter is recommended because it will give additional protection from electric shock.

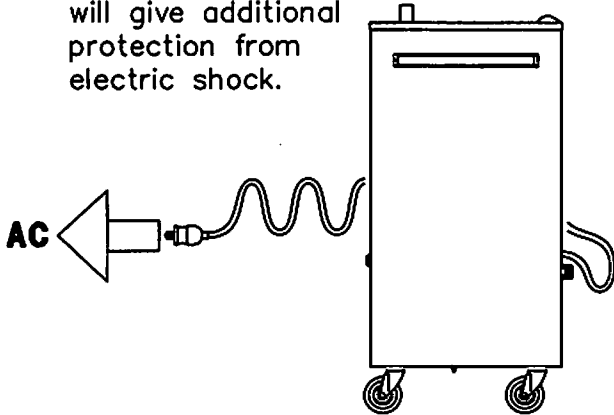

8 Facing the front of the unit, find the red power switch in the lower, center of the unit.

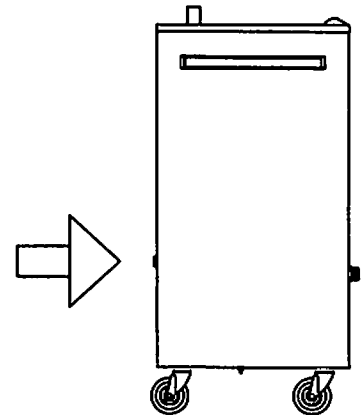

9 Turn the power switch to the ON position. The red light will go on.

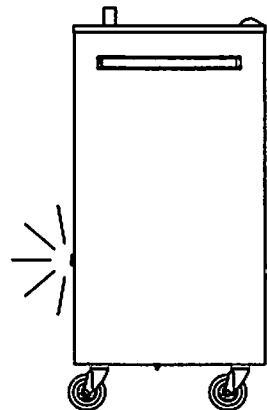

EMPTYING

- 1** Facing the front of the unit, find the red power switch in the lower, center of the unit. Turn the power switch to the OFF position. The light will go out.

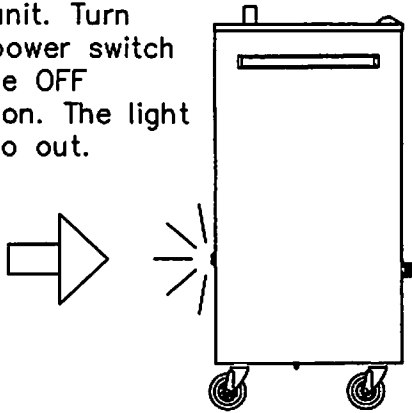

- 2** Unplug the unit.

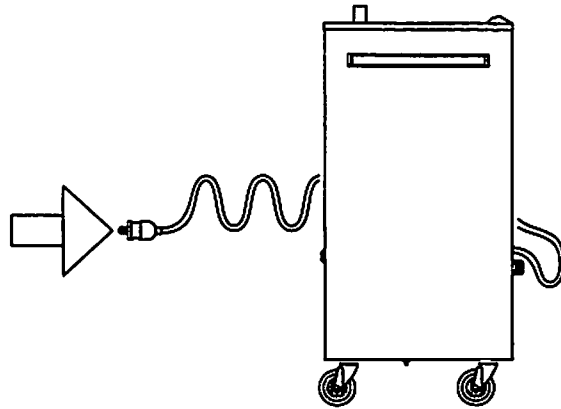

- 3** Let the water cool to room temperature. Remove the Thermal Packs and the wire rack.

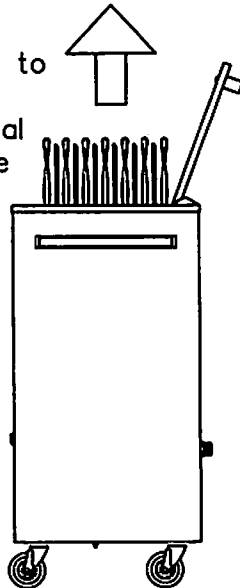

- 4** Attach an Auxiliary Drain Hose (-ADH) or an ordinary garden hose to the drain outlet. Turn the drain lever 1/4 turn so the lever is in line with the piping.

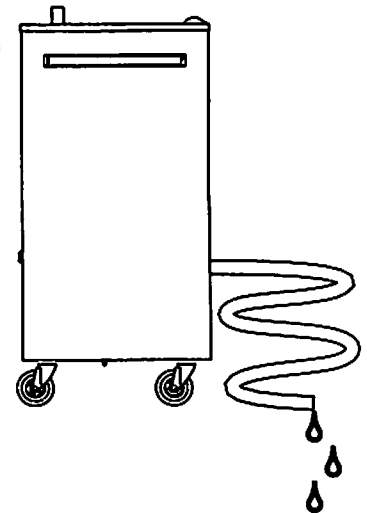

CHECKING OUT my Thermalator™

Before the FIRST use, check the following:

- 1-The Thermalator™ should be level. The wheels should be locked.
 - 2-The Thermalator™ should be plugged directly in to a properly grounded GFCI receptacle. Do not use an extension cord. Undersized extension cords can overheat.
 - 3-The Thermalator™ should be in good condition.
 - 4-Make sure the drain valve is closed.
- Your new Thermalator™ is now ready for use. If you have any questions about SETTING UP or CHECKING OUT your unit, please call the phone number listed on the inside front cover.

USING the Thermal Pack

1-For each use:

1 Open the lid.

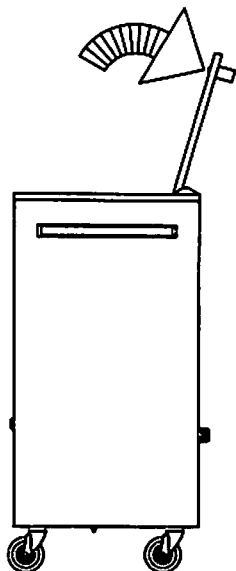

2 Using tongs, carefully remove the Thermal Pack.

CAUTION: the Thermal Pack can cause skin burns.

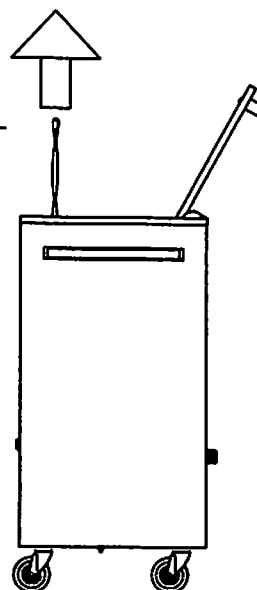

3 Wrap the pack in a Thermal Pack Cover or 5 or 6 layers of terry toweling.

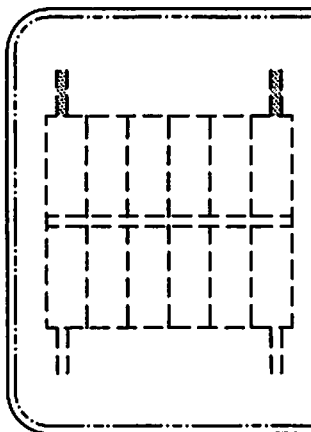

4 Put the wrapped pack on the area to be treated for a pre-set treatment time.

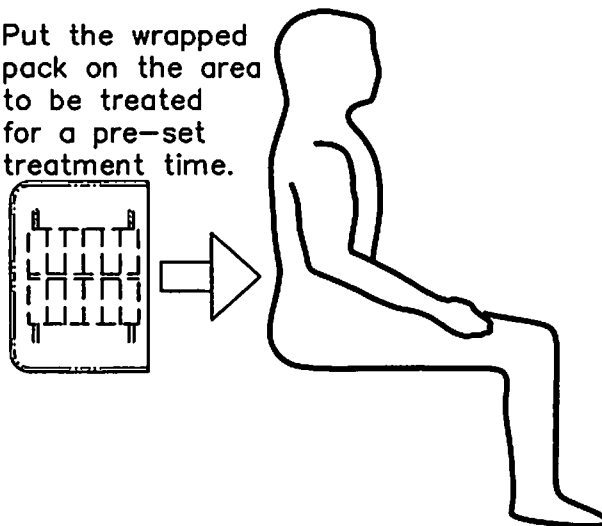

5 Remove the Thermal Pack from the patient.

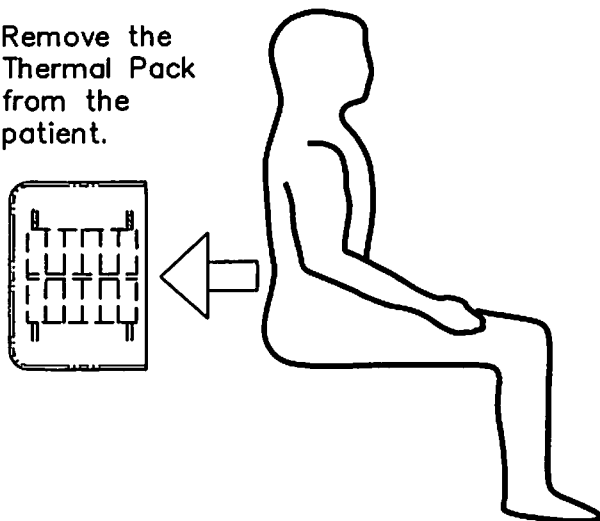

6 Remove the Thermal Pack Cover or toweling. Hang to dry or launder.

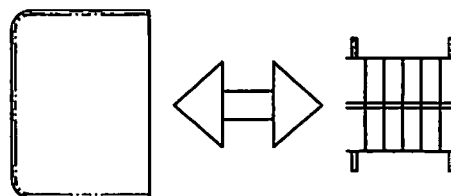

7 Return the pack to the Thermalator™.

If the blue tab was up, put the white tab up now. Work your way from first to last, reversing tabs each time.

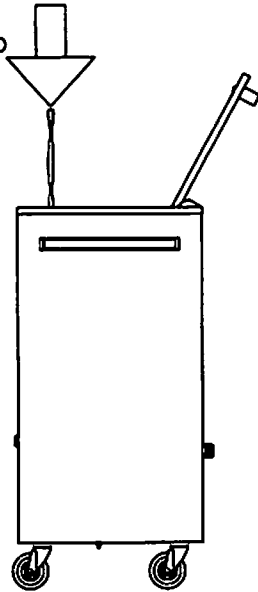

8 Close the lid. The Thermal Pack will be reheated within about 15 minutes and ready for use.

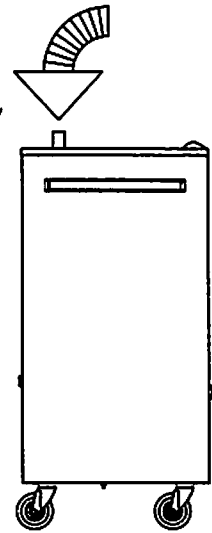

CAUTION

- ~DO NOT use the Thermal Pack on sensitive skin or on areas of poor circulation.
- ~DO NOT stack Thermal Packs on top of each other for more heat.
- ~DO NOT use wet or moist toweling to wrap the Thermal Pack.
- ~DO NOT apply the Thermal Pack over cuts, lacerations, or abrasions.
- ~DO NOT use the Thermal Pack in combination with balms, linament or ointments.
- ~DO NOT use additives, disinfectants or other chemicals in the water.
- ~Have the patient tell you if the Thermal Pack is too hot.
- ~Use 5 or 6 layers of ordinary heavy toweling or Thermal Pack Covers to wrap the Thermal Pack before applying to the patient.
- ~Use extra care and judgement when using the Thermal Pack with infants and the elderly.
- ~Use extra care and judgement when using the Thermal Pack on thin skin or "bony" areas.
- ~Apply the Thermal Pack to the patient; DO NOT have the patient lie on the Thermal Pack.
- ~Cover the Thermal Pack with extra layers of towel on the top to slow heat loss.
- ~During treatment, check the condition of the patient and the treated area often.
- ~When handling the Thermal Pack, use the corner loops to avoid skin burns.

2-Daily use:

1 Add more water, if necessary, to cover the Thermal Packs. Uncovered packs may be damaged during heating.

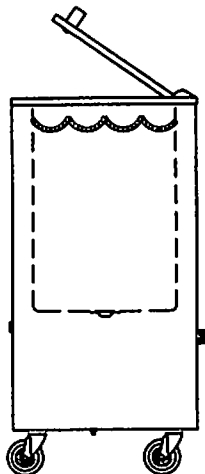

2 Place all the blue tabs in the same reference (either all up or all down) to start the day.

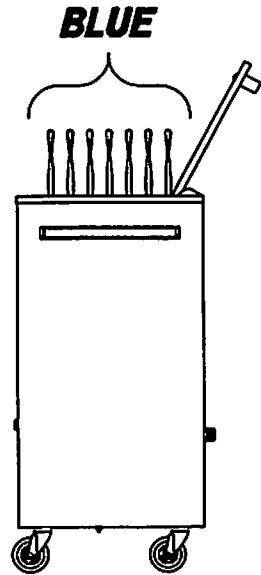

3-Periodic use:

Your water temperature is factory preset at a normal operating temperature, about 165° F. The thermostat is very sensitive; even a small adjustment can raise or lower the temperature several degrees. To adjust the temperature, you need the following:

- Small, flat blade screwdriver.
- Thermometer capable of 180°F.

- 1** Facing the back of the unit, find metal temperature knob between the 2 screws in the lower middle of the unit.

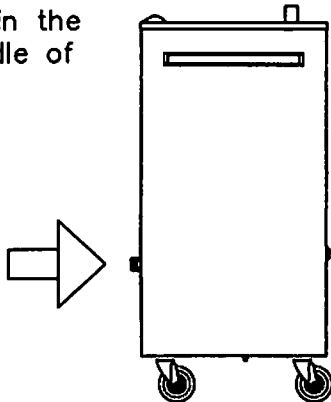

- 2** Using the screwdriver, turn the stem clockwise to increase the temperature. Allow the temperature to stabilize, and measure the water temperature with the thermometer.

CAUTION: Sensitive thermostat; a small adjustment changes several degrees.

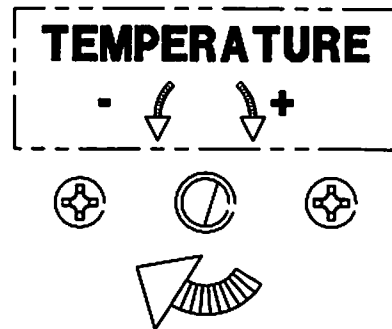

USING the wire rack

Your Thermalator™ uses many different sizes of Thermal Packs. For Half, Cervical or Myofacial, use the rack adapter as shown. For Standard, Knee/Shoulder, 10" x 18" and 10" x 24", use the wire inserts. For Oversize, use only the wire rack.

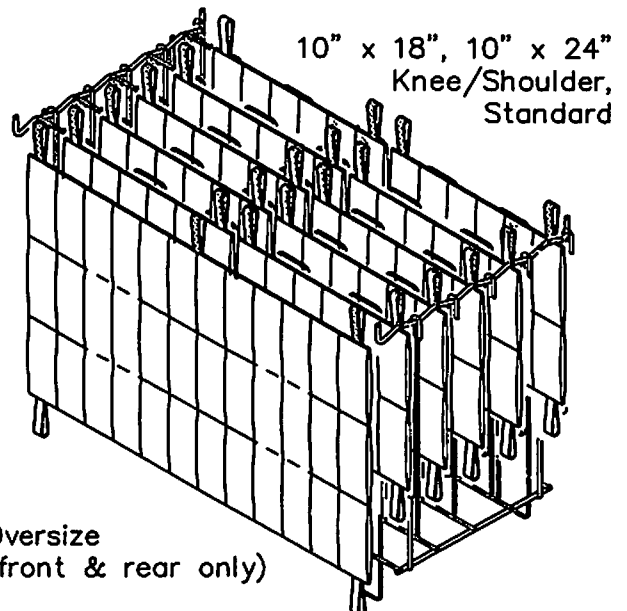
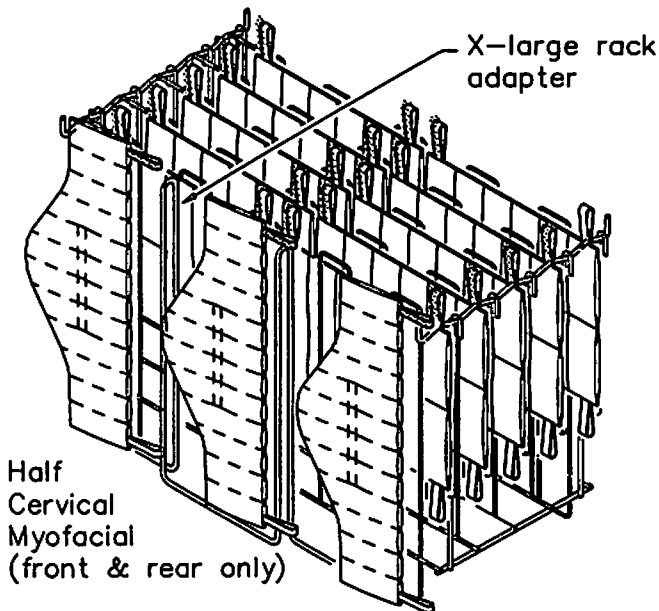

CLEANING

1-You will need:

- Sponge, cloth or non-abrasive cleaning pad.
- Stainless steel cleaner, such as Sheila Shine® or 3M Stainless Steel Cleaner & Polish.**
- Synthetic abrasive cleaning pad,

- such as Scotch-Brite®.**
- Soap, ammonia, detergent or mild disinfectant.
- Household wax (Color-coated units only).
- Mild acid such as white vinegar.**

**Use ONLY on stainless steel surfaces.



CAUTION



DO NOT use steel wool – it will rust and embed in the stainless steel surface. DO NOT use bleach, chlorinated solvents or other chemicals—they will leave a residue on your unit and will shorten the life of the Thermal Packs.

2-Routine Cleaning (every 2 weeks or as needed).

- 1** Facing the front of the unit, find the red power switch in the lower, center of the unit. Turn the power switch to the OFF position. The light will go out.

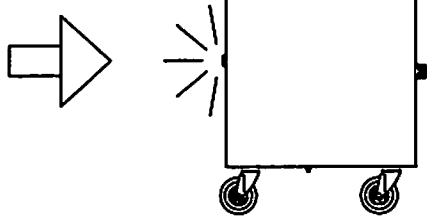

- 2** Unplug the unit.

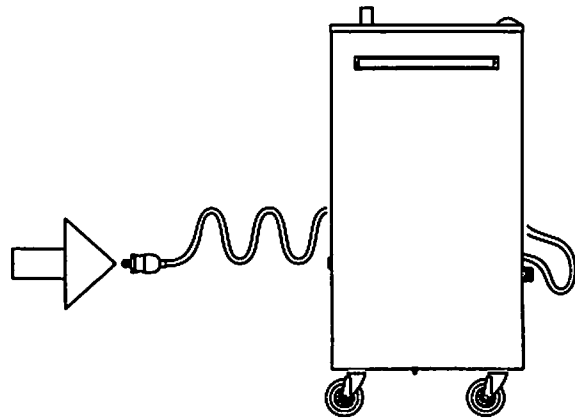

- 3** Let the water cool to room temperature. Remove the Thermal Packs and the wire rack.

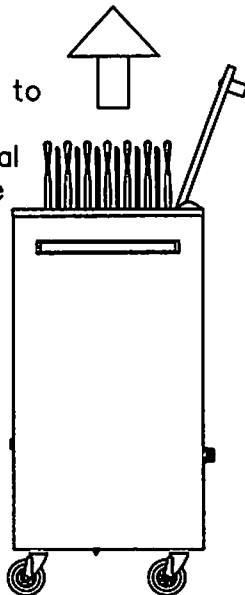

- 4** Attach an Auxiliary Drain Hose (-ADH) or an ordinary garden hose to the drain outlet. Turn the drain lever 1/4 turn so the lever is in line with the piping.

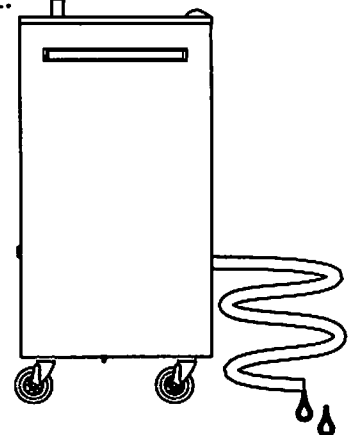

5 Wash inside and outside with a sponge, cloth or cleaning pad using a mild soap solution. For "hard water" spots and scale, scrub the area using a strong solution of vinegar and water. Let stand for 5 minutes.

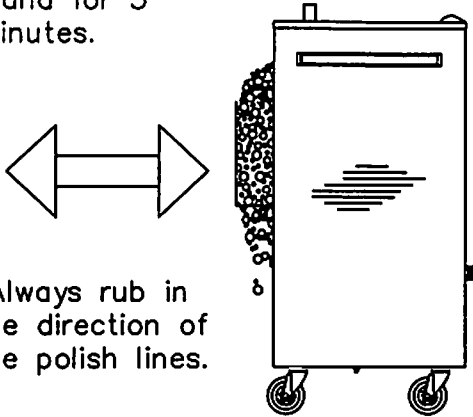

*Always rub in the direction of the polish lines.

6 Rinse thoroughly with clean tap water.

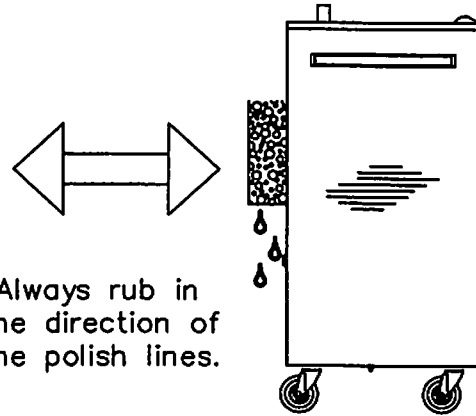

*Always rub in the direction of the polish lines.

7 Dry with a soft cloth to avoid water marks.

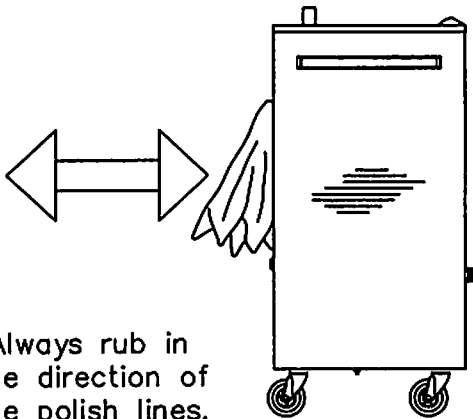

*Always rub in the direction of the polish lines.

8 Scrub your Thermal Packs with warm soap and water. Packs may also be boiled, but this will shorten the life of your Thermal Pack.

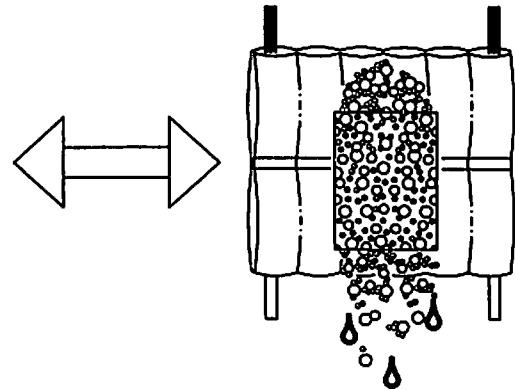

2-Special Cleaning (Color coated surfaces).

1 Follow steps 1-4 on page 13. Wash the outside with a sponge or cloth using a mild soap solution. Do not use abrasive compounds, cleanser or pads. Verify the resistance to chemicals and solvents before using.

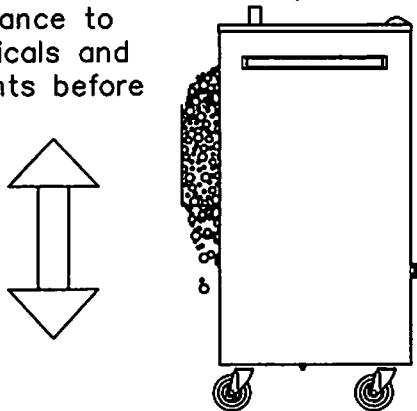

2 Rinse thoroughly with clean tap water.

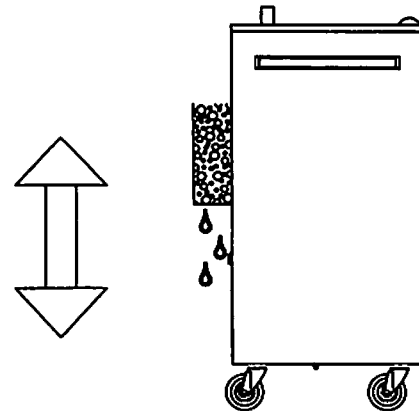

3 Dry with a soft cloth to avoid water marks.

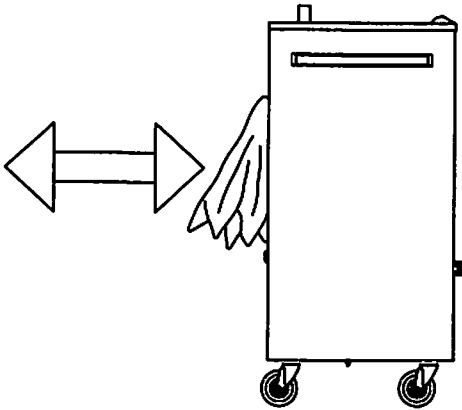

4 To maintain and restore gloss, use a household wax.

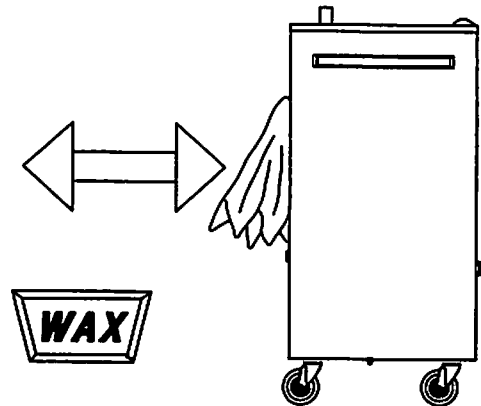

3-Special Cleaning (Stubborn stains, spots and scratches).

1 Follow steps 1–4 on page 13. Apply the stainless steel cleaner to a damp cloth, sponge, stainless steel wool or pad. Follow manufacturer's instructions for using cleaner.

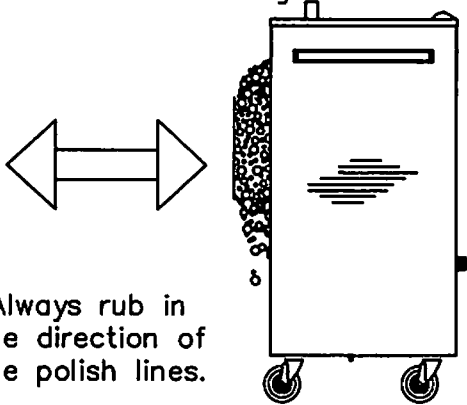

*Always rub in the direction of the polish lines.

2 Wash inside and outside with a sponge, cloth or cleaning pad using a mild soap solution.

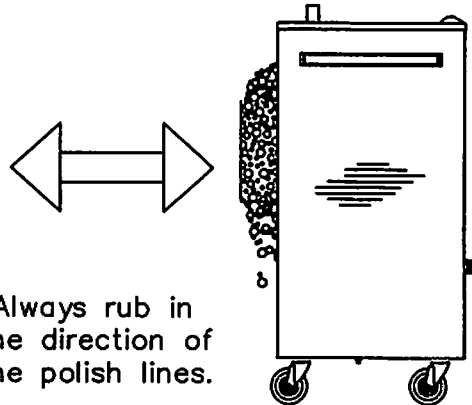

*Always rub in the direction of the polish lines.

3 Rinse thoroughly with clean tap water.

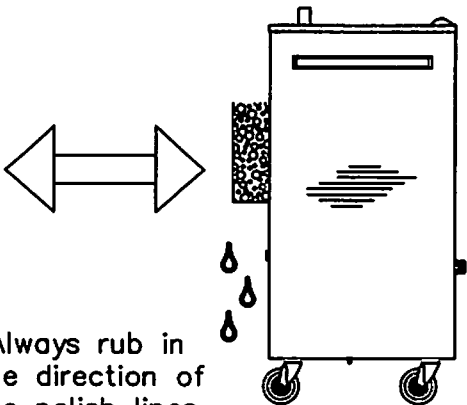

*Always rub in the direction of the polish lines.

4 Dry with a soft cloth to avoid water marks.

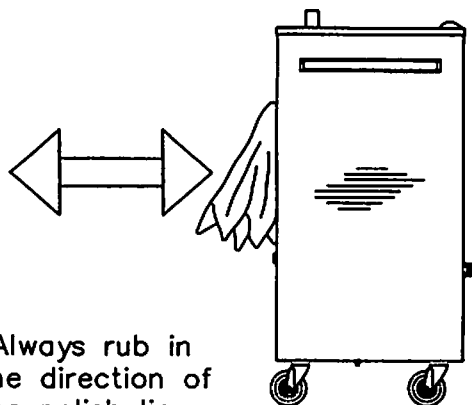

*Always rub in the direction of the polish lines.

MAINTENANCE

The Thermalator™ design is nearly maintenance-free. It should, under most conditions, give many years of reliable service. Clean and replace the Thermal Packs as described below.

1. Routine Maintenance (as needed)

- * Follow steps 1–8 on pages 13 and 14 for Routine Cleaning.
- * Always keep the Thermal Packs under water. Replace any water that evaporated.
- * Destroy or discard any contaminated Thermal Packs.

2. Monthly Maintenance

- * Follow steps 1–4 on page 15 for cleaning stains, spots and scratches.
- * Clean the wire rack and insert using the step 5–7 on page 14.
- * Keep the pH (a measure of acidity of the water) between 7.4 and 7.8 to reduce the scaling and residue build-up. Contact a swimming pool supply company for information and supplies.

3. Yearly Maintenance

- * Replace worn out Thermal Packs. When the packs begin to wear out, the non-toxic filler material oozes through the fabric and seams. The individual cells seem empty. These packs don't hold the heat. Throw away worn Thermal Packs.
 - * Have a professional electrician thoroughly check the following:
 - 1 – Test for leakage current, dielectric strength, and receptacle polarity and ground. If you need the test details, call the phone number listed on the inside front cover.
 - 2 – Check the power cord and plug. They should be free of cuts, abrasion and other damage. Replace the power cord assembly if it is damaged. Use only factory authorized replacement parts.
 - 3 – Remove the cover and check all electrical components and connections. Replace any parts that are in questionable condition. Use only factory authorized replacement parts.
-

STORAGE

1. Storing the Thermalator™

- * Follow steps 1–7 on pages 13 and 14 for Routine Cleaning.
- * Place the Thermalator™ upright in a dry area away from any chemicals.

2. Storing the Thermal Packs

- * Follow step 8 on page 14 for Routine Cleaning.
- * Moist and cold:
 - 1–Put the moist Thermal Pack in a plastic bag.
 - 2–Seal the plastic bag.
 - 3–Store the bag in the freezer (recommended) or refrigerator.
- * Dry:
 - 1–Air dry the Thermal Pack completely in a well ventilated area. The filler will become hard and caked. This doesn't hurt the bags; more PRE-SOAKING time is then necessary.
 - 2–Store in a dry area away from any chemicals.

TROUBLESHOOTING

Problem	Cause	Solution
Water doesn't get hot, even though unit is plugged in and switch is ON.	<ul style="list-style-type: none"> -Circuit breaker is off. -Thermostat is not working. -Heating element is burned out. -The ON/OFF switch is broken. 	<ul style="list-style-type: none"> -Turn on the circuit breaker. -Replace the thermostat. -Replace the heating element. -Replace the switch.
Water is cloudy.	<ul style="list-style-type: none"> -The Thermal packs are worn out (seeping). -Too long between cleanings. 	<ul style="list-style-type: none"> -Replace the Thermal Packs. -Drain, clean and refill.
Thermal Packs too hot.	<ul style="list-style-type: none"> -The thermostat is set too high. -The thermostat is broken. 	<ul style="list-style-type: none"> -Adjust the thermostat. -Replace the thermostat.
Thermal Packs too hot & then too cool.	<ul style="list-style-type: none"> -The thermostat is broken. 	<ul style="list-style-type: none"> -Replace the thermostat.
Thermal Packs too cool.	<ul style="list-style-type: none"> -The thermostat is set too low. -The thermostat is broken. -There is a power failure. 	<ul style="list-style-type: none"> -Adjust the thermostat. -Replace the thermostat. -Check the circuit and turn on the breaker.
Rust in unit.	<ul style="list-style-type: none"> -Contact with ferrous metal. 	<ul style="list-style-type: none"> -Remove the ferrous metal item from the unit—usually a staple, paper clip, safety pin, etc. Clean thoroughly.

Refer to the Technical Information section for replacement parts.

For more help call the number listed on the inside front cover.

TECHNICAL INFORMATION

Electrical Information

The Thermalator™, Model T-12-M requires 120 Volts AC, 60 Hz and will draw 9 amps; the T-12-M-V requires 220 Volts AC, 50/60 Hz and will draw 5 amps. The 8' power cord ends with a "Hospital Grade" plug, an Underwriter's Laboratories Inc. verification for abuse resistant wiring wiring devices. The other components include a 1000 watt resistive type heating element, a double pole, single throw (DPST) lighted ON/OFF switch, a hydraulic capillary type thermostat for temperature control, and a snap-action thermal overheating sensor.

Wiring Diagram

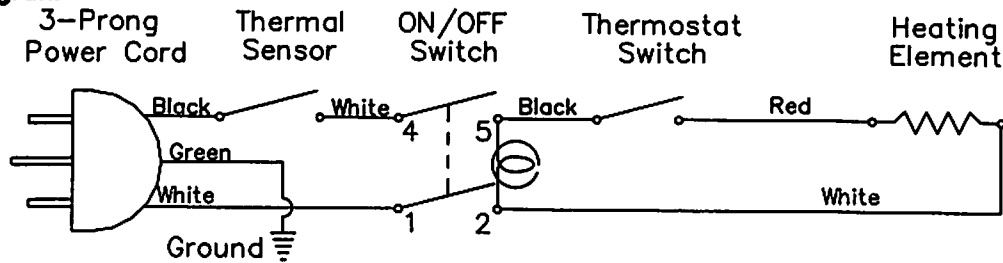

Replacement Parts - Model T-12-M (120VAC 60 Hz)

ITEM	PART NUMBER	DESCRIPTION
1	0116-008-000	#6-32 x 3/16" phillips screw
2	0116-011-000	#10-32 x 5/16" phillips screw
3	0126-058-000	1/4"-20 x 1-1/2" phillips screw
4	0126-551-000	1/4"-20 x 1" phillips screw
5	0207-020-000	3/8"-16 x 1" hex head cap screw
6	0302-004-000	#10-32 hex nut
7	0302-007-000	3/8"-16 hex nut
8	0308-010-000	#10-32 Nylok nut
9	0331-031-000	1/4" fender washer
10	0337-003-000	3/8" lockwasher
11	0338-004-000	Plastic washer
12	0710-450-000	Thermal Overheating Sensor
13	0711-123-001	Wiring harness-Red, 12"
14	0711-124-001	Wiring harness-Black, 14"
15	0711-125-001	Wiring harness-White, 8"
16	0711-126-001	Wiring harness-White, 8"
17	1818-422-000	Hose adapter
18	2054-009-000	1/2" x 5" PVC nipple
19	6505-030-001	Cord set-hospital grade with terminals
20	6505-500-000	Heating Element (120volt/1000W) w/ washers & nuts
21	6505-505-000	Thermostat (65-170 °) w/ washers & nuts
22	6505-510-000	On/Off switch (DPST w/ lamp)
23	6505-520-000	Strain relief
24	6507-008-000	3" caster
25	6507-058-000	3" caster with brake
26	6512-005-000	Drain valve
27	6702-050-002	Thermometer Clamp Assembly
28	6702-150-000	Handle - large
29	6702-518-001	Electrical cover assembly
30	6702-520-199	Electrical panel
31	6702-531-000	Inner tank tensioner
32	6702-650-000	Wire rack - X-large (stainless steel)
33	6702-659-000	Insert Hanger - X-large (stainless steel)
34	6702-660-000	Rack Adapter - X-large (stainless steel)

See **ACCESSORIES** Section for replacement Thermal Packs and Covers.

T-12-M (120 VOLTS)

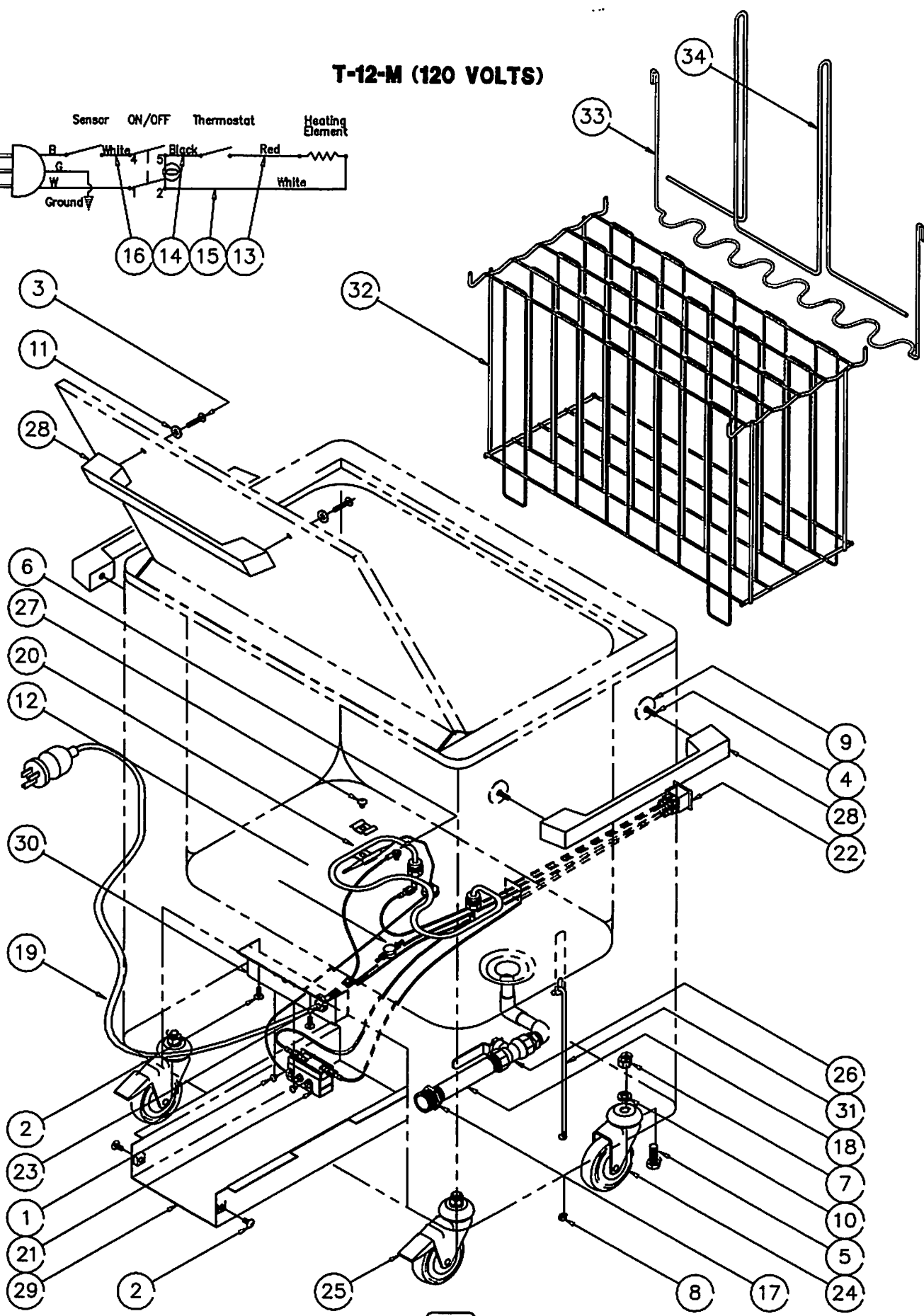
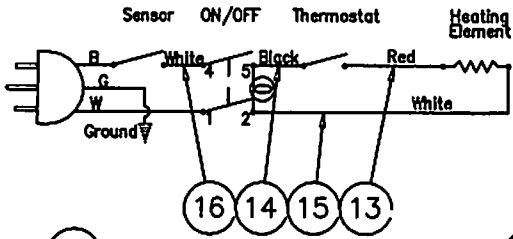

Wiring Diagram

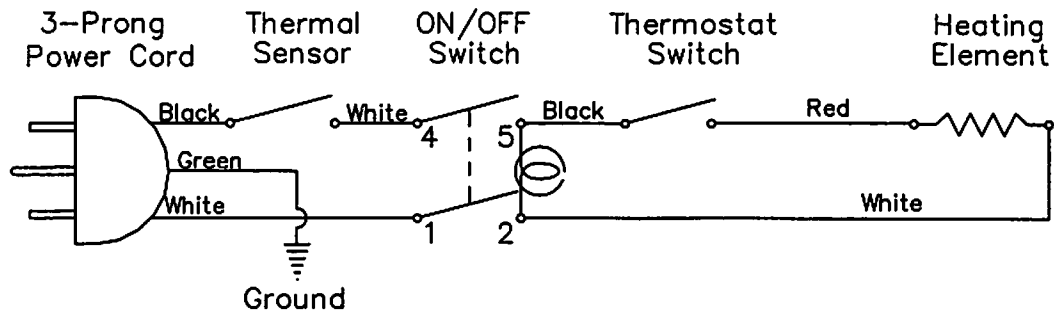

Replacement Parts - Model T-12-M-V (220 VAC 50/60 Hz)

ITEM	PART NUMBER	DESCRIPTION
1	0116-008-000	#6-32 x 3/16" phillips screw
2	0116-011-000	#10-32 x 5/16" phillips screw
3	0126-058-000	1/4"-20 x 1-1/2" phillips screw
4	0126-551-000	1/4"-20 x 1" phillips screw
5	0207-020-000	3/8"-16 x 1" hex head cap screw
6	0302-004-000	#10-32 hex nut
7	0302-007-000	3/8"-16 hex nut
8	0308-010-000	#10-32 Nylok nut
9	0331-031-000	1/4" fender washer
10	0337-003-000	3/8" lockwasher
11	0338-004-000	Plastic washer
12	0710-450-000	Snap-off Thermal Protector
13	0711-123-001	Wiring harness-Red, 12"
14	0711-124-001	Wiring harness-Black, 14"
15	0711-125-001	Wiring harness-White, 8"
16	0711-126-001	Wiring harness-White, 8"
17	1818-422-000	Hose adapter
18	2054-009-000	1/2" x 5" PVC nipple
19	6505-033-001	Cord set-hospital grade with terminals
20	6505-500-000	Heating Element (220VAC/1000W) w/ washers & nuts
21	6505-505-000	Thermostat (65-170 °) w/ washers & nuts
22	6505-515-000	On/Off switch (DPST w/ lamp)
23	6505-520-000	Strain relief
24	6507-008-000	3" caster
25	6507-058-000	3" caster with brake
26	6512-005-000	Drain valve
27	6702-050-002	Thermometer Clamp Assembly
28	6702-150-000	Handle - large
29	6702-518-001	Electrical cover assembly
30	6702-520-199	Electrical panel
31	6702-531-000	Inner tank tensioner
32	6702-650-000	Wire rack - X-large (stainless steel)
33	6702-659-000	Insert Hanger - X-large (stainless steel)
34	6702-660-000	Rack Adapter - X-large (stainless steel)

See ACCESSORIES Section for replacement Thermal Packs and Covers.

T-12-M-V (220 VOLTS)

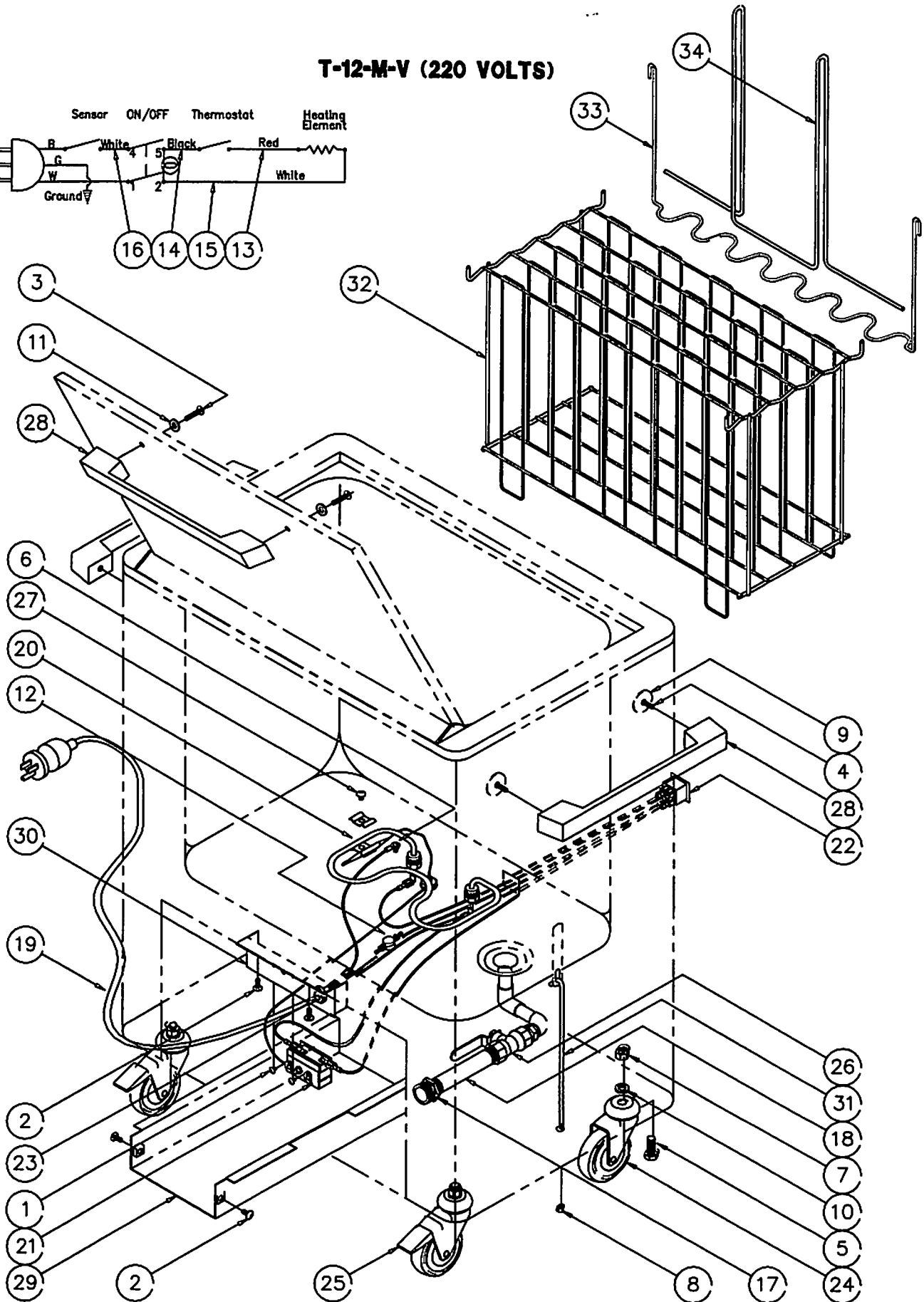
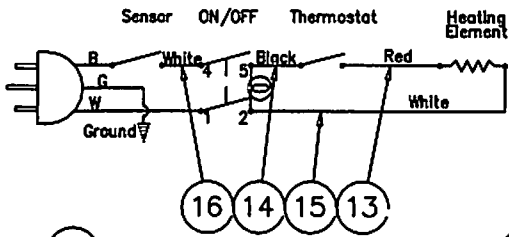

ACCESSORIES

Thermal Pack Covers

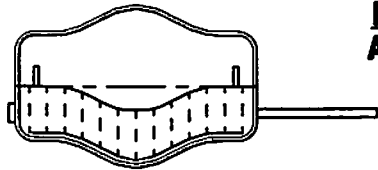

Myofacial Size
ATC1-All Terry

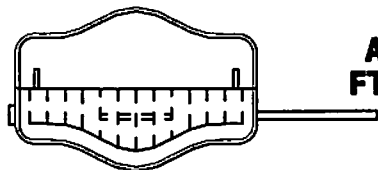

Cervical Size
ATC2-All Terry
FTC2-Foam Filled

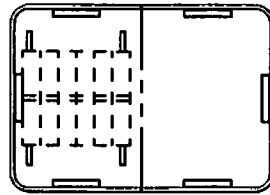

Standard Size
ATC4-All Terry
FTC4-Foam Filled
 For Standard & Half

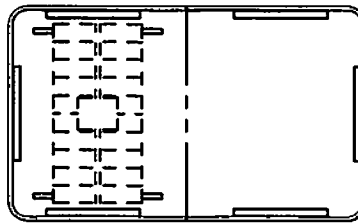

Oversize
ATC6-All Terry
FTC6-Foam Filled
 For Oversize, 10" x 24",
 10" x 18" & Knee/
 Shoulder

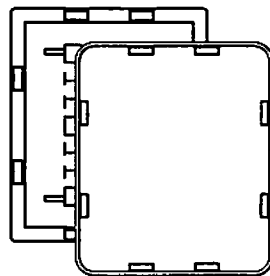

Vinyl-Terry
VTC4-Standard Size
VTC6-Oversize

Thermal Packs

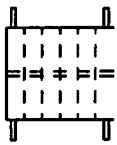

TST1

Standard Size
 10" x 12"
 (25cm x 30cm)
*The most versatile Thermal
 Pack size.*

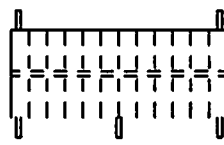

TSL1

Spinal Size
 10" x 24"
 (25cm x 60cm)

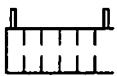

THF1

Half Size
 5" x 12"
 (12cm x 30cm)

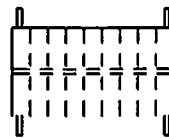

TSL2

Spinal Size
 10" x 18"
 (25cm x 45cm)

Thermal Packs

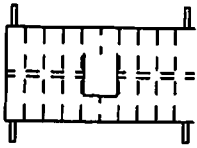

TKS1

Knee-Shoulder Size

10" x 20"
(25cm x 50cm)
Center cutout lets pack conform to joints.

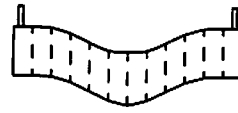

TMY1

Myofacial Size

23" Long
(58cm)
Easily conforms for treatment of neck, face and temporomandibular joint.

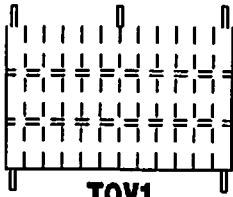

TOV1

Oversize
15" x 24"
(37cm x 60cm)
Allows treatment of larger areas.



TCV1

Cervical Size

24" Long
(60cm)
Easily conforms to the neck area.

Combination Sets

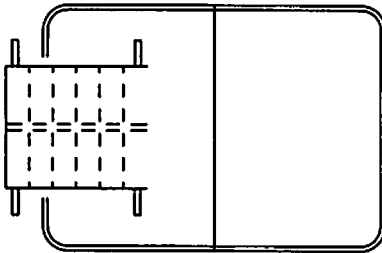

**Standard Set
CL1**
Includes a Standard Thermal Pack & All Terry Cover

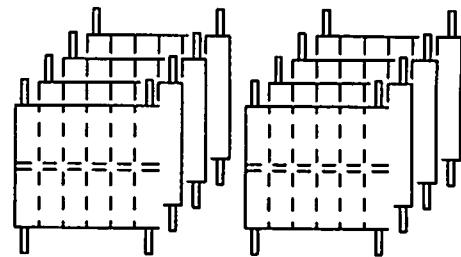

Clinical Set-CL8
Includes (8) Standard Thermal Packs

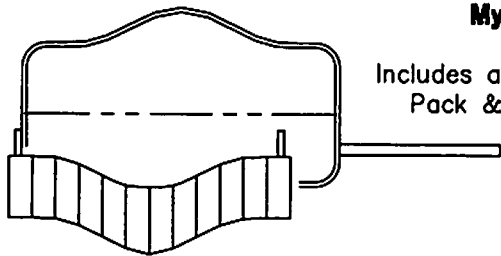

**Myofacial Set
CL2**
Includes a Myofacial Thermal Pack & All Terry Cover

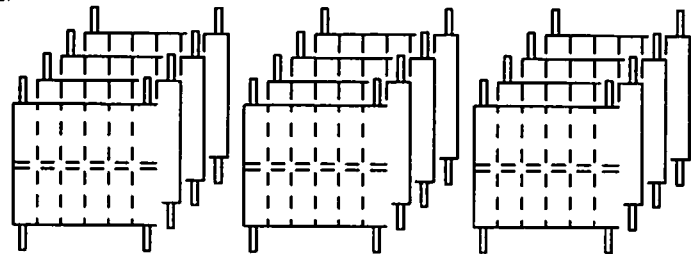

Institutional Set-CL12
Includes (12) Standard Thermal Packs

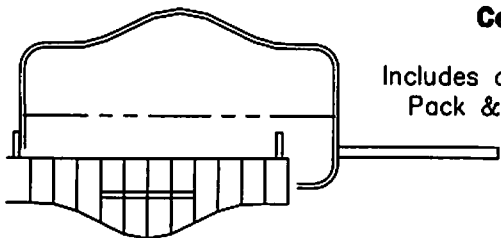

**Cervical Set
CL3**
Includes a Cervical Thermal Pack & All Terry Cover



Whitehall
Manufacturing

WHITEHALL MANUFACTURING, INC.

A Division of Acorn Engineering Company

MAIL: P.O. Box 3257
City of Industry, CA 91744 U.S.A.

PHYSICAL/SHIPPING: 15125 Proctor Avenue
City of Industry, CA 91746 U.S.A.

TOLL FREE: 800-782-7706

LOCAL: 626-968-6681

FAX: 626-855-4862

E-MAIL: info@whitehallmfg.com

WEB SITE: www.whitehallmfg.com

Distributed by:

