

**MADE
IN THE USA****Product Description:**

- Kit Includes:
 - RS001-0233 Respiratory Hygiene Station
 - Holds two boxes of face masks, one - two boxes of facial tissues or one box of gloves, and one hand sanitizer bottle or hand sanitizing wipe canister
 - BOWMAN® Signature Series - Cherry Fauxwood ABS Plastic
 - KS010-0420 Floor Stand
 - Black Powder-Coated Steel
 - MP-070 Sign Holder - Vertical
 - Holds 8.5" x 11" signage
 - Clear PETG Plastic
- Assembly hardware included

Primary Area for Product Usage:

- All ports of entry
- Anywhere respiratory hygiene products are needed

Dispenses:

- Left: Bottles no larger than 4.06"W x 4.06"D or 4.00" diameter (10.5 cm x 10.5 cm)
- Middle: Box(es) no larger than 7.75"W x 4.00"H x 4.75"D (19.7 cm x 10.2 cm x 12.1 cm)
- Right: Box(es) no larger than 5.50"W x 10.00"H x 4.75"D (14.0 cm x 25.4 cm x 12.1 cm)

Product Specifications (overall assembled dimensions):

- 18.00"W x 58.36"H x 18.00"D (45.7 cm x 148.2 cm x 45.7 cm)
- 19.2 lbs (8.7 kg) - approximated

Package Specifications:

- Package Quantity: 1 per case
- 36"L x 20"W x 6"H (91.4 cm x 50.8 cm x 15.2 cm)
- 24.0 lbs (10.9 kg) - approximated



Sanitizer, face masks, and tissues not included



Installation

Always mount dispensers securely *prior* to loading with product.

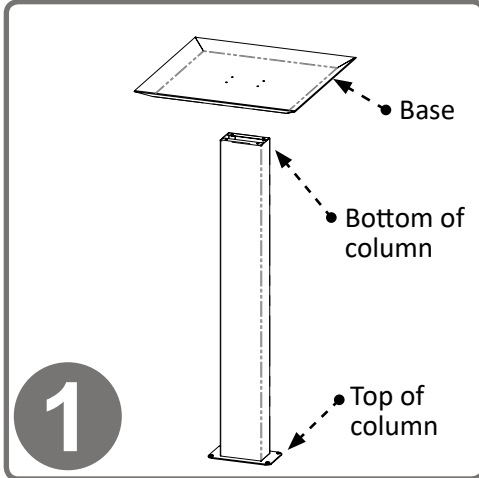

To secure base to column, turn column upside down (with top plate down) and place base inverted, as shown, on column.

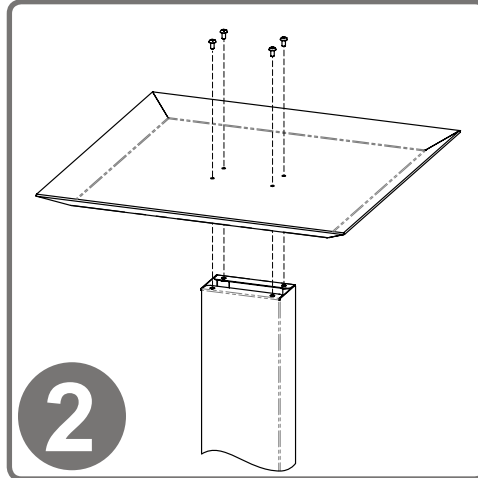

Use Phillips screwdriver to secure base to column with (4x) screws (10-32 x 5/16").

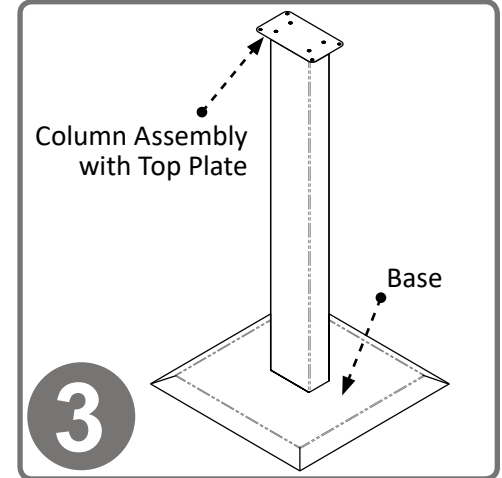

Turn stand right side up, so the base is on the floor.

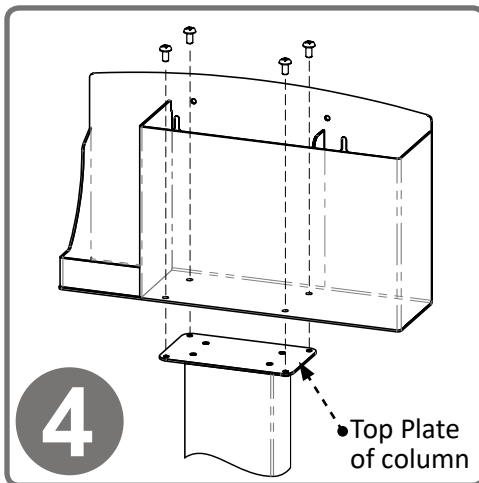

Attach the RS001-0233 Respiratory Hygiene Station to the column using (4x) screws included with stand. Tighten.

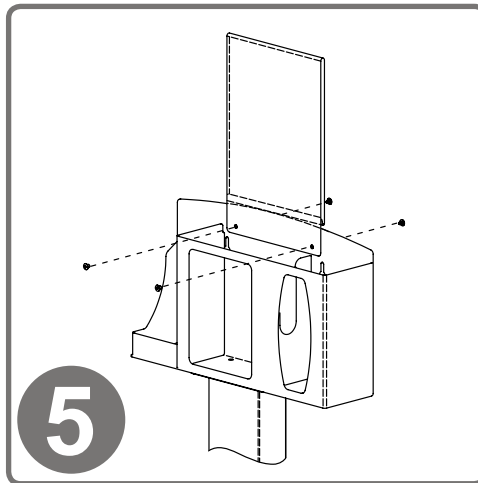

To mount the MP-070 Sign Holder, align the holes of the holder with the holes of the dispenser. With a flathead screwdriver, attach using (2x) barrel screws included with sign holder.

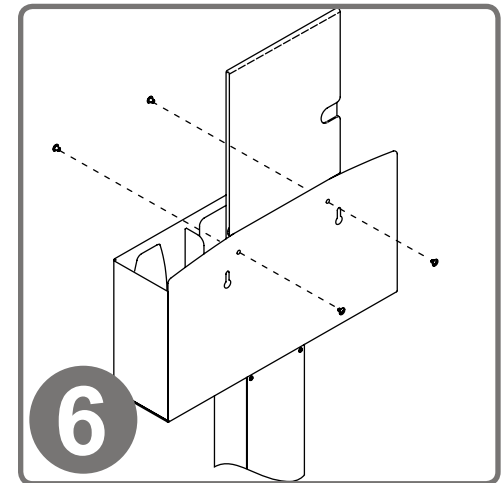

Thumb access to signage goes toward back of dispenser.

Parts included:

- Base
- Column
- Hygiene Station
- Sign Holder
- Hardware
 - (8x) 10-32 x 5/16" Phillips head screws
 - (2x) barrel screws

Tools Required:

- Phillips Screwdriver
- Flathead Screwdriver



RS001-0233

Fauxwood ABS Plastic

KS010-0420

Powder-Coated Steel

MP-070

PETG Plastic

Material Characteristics

Designed for Long-Term, Heavy-Duty Applications

The combination of copolymers (Acrylonitrile, Butadiene, and Styrene) gives ABS an excellent combination of strength, rigidity, and toughness. The fauxwood finish is ARVINYL laminate created from a semi-rigid film.

ABS is chemical and stress-crack resistant. It is tough, dimensionally stable, and will hold up to long-term use. To ensure product longevity, fauxwood products should not be mounted in very hot or cold areas.

Our fauxwood material is engineered to have a natural grain appearance both in Cherry and Maple finishes. The two color choices provide a visually appealing, upscale option to any area.

Designed for Long-Term Use

Our steel dispensers and stands are coated with polyester powders which makes them highly resistant to corrosion.

Powder-coated steel is ideal for dispensers used in a healthcare or an industrial setting because it is impact resistant and is not effected by extremes in temperature.

Dispensers and stands made of powder-coated steel are both attractive and functional, providing years of service.

Designed for Long-Term, Heavy-Duty Applications

Copolyester resin is designed for heavy-duty applications, and is used by BOWMAN® Dispensers. We never use acrylic in our products.

Copolyester (PETG) is typically 15-20 times tougher than general purpose acrylic. PETG is made to withstand handling and reduce losses due to breakage.

PETG resists a variety of chemicals and commonly used cleaning agents. It is tough and durable (not brittle), providing years of trouble-free functionality and long life.

Clear optical characteristics mean the viewer can see the content, read text, and see true colors through the material. It complies with FDA regulations for food contact.

Care and Cleaning

BOWMAN® Signature Series products can be cleaned with standard hospital cleaning products. Petroleum-based oils, solvents, and paints should not be used.

Standard hospital cleaning supplies can be used.

For best results, clean by washing the surface with a diluted solution of a mild, non-abrasive detergent in cold or warm water and a non-abrasive cloth. Standard hospital cleaning supplies can be used.

Dry with a soft cloth. Do not use any solvent-based materials, abrasives (e.g. Scotch-brite, steel wool), or apply excessive force during cleaning.

Most cleaning chemicals do not weaken the surface or cause damage to the material. Suggested cleaning method is to use a soft cloth, warm water, and mild soap.