

comfort
Soul

INSTRUCTION MANUAL

LUMINA ELITE



PRODUCT DESCRIPTION

■ STANDARD FEATURES:

- ComfortSoul UltraQuiet™ Linear Actuator: Load tuned whisper quiet lifting mechanism.
- ComfortSoul Elite-3 Top™: Full electric three sectional top.
- ComfortSoul DuraSoft™ Upholstery: Luxurious, soft, durable, waterproof, and environmentally friendly surface.
- ComfortSoul UltraPlush™ Cushioning System: 4 inches of multi-layered UltraPlush™ Padding engineered at different densities to provide ultimate support and comfort.
- ComfortSoul Z-lift™ Ultra Durable Steel Base: increased versatility while maintaining stability.
- ComfortSoul SmoothLock™ End Attachment Support: proprietary end attachments glide smoothly into position and are conveniently located at both ends of table.
- ComfortSoul ClickLock™ Side Attachment Support: side attachment connectors that lock attachments into place and easily release with a push of a button.
- Electronically adjustable height (24 to 33 inches).
- Independent electronic adjustment for back, leg, and height.
- Fully controlled with Electronic Multi-Function Remotes.
- 700 lbs. Maximum Weight

■ INCLUDED ACCESSORIES:

- ComfortSoul ClickLock™ Arm Rest Set.
- ComfortSoul SmoothLock™ Face Cradle: provides smooth and easy adjustments for Face Cradle Pillow and Head Pillow.
- ComfortSoul MemoryFit™ Face Cradle Pillow: provides your clients with the most comfortable face-down position possible.
- ComfortSoul PlushFit™ Neck Pillow: provides extra comfort and support for the neck.
- ComfortSoul PlushFit™ Head Pillow: provides taller clients with head support even beyond the length of the bed.
- Electronic Multi-Function Hand Remote.

■ OPTIONAL ACCESSORIES:

- Electronic Multi-Function Foot Remote
- Bolster Accessories
- Terry Cloth Linen Sets

PRODUCT DESCRIPTION

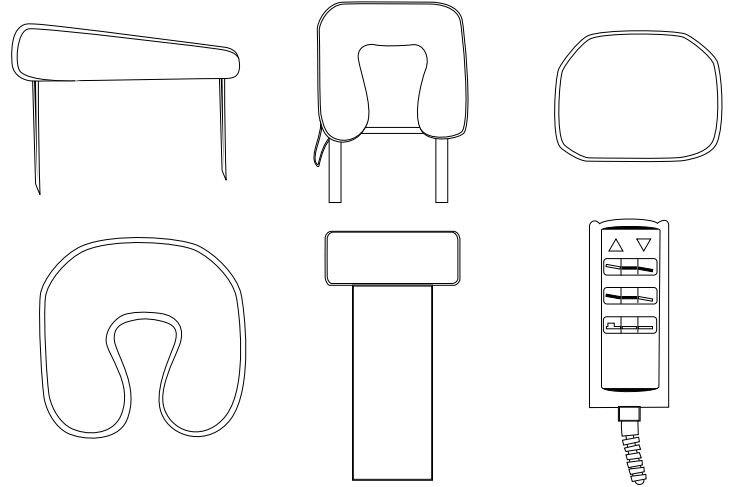
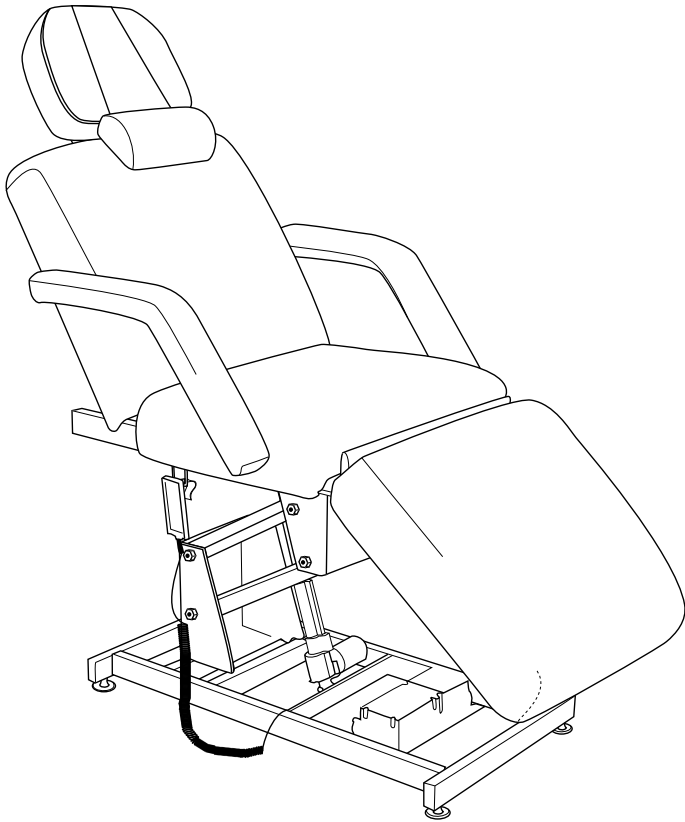

CHAIR SPECIFICATIONS:

1. Default Position: 74" x 28" x 24" (L x W x H)
2. Section Lengths: 25" x 22" x 26" (Back x Middle Section x Leg)
3. Arm Rest Dimensions: 32" x 5" x 3" (L x W x H)
4. Cushion Thickness: 4"
5. Base Dimensions: 63" x 26" (L x W)
6. Weight: 220 lbs
7. Face Cradle Pillow: 12" x 12" x 2" (L x W x Thickness)
8. Head Pillow: 16" x 12" x 2" (L x W x Thickness)
9. Neck Pillow: 14" x 10" x 2" (L x W x Thickness)

INCLUDED ACCESSORIES:

1. ComfortSoul ClickLock Arm Rest.
2. ComfortSoul SmoothLock™ Face Cradle: provides smooth and easy adjustments for Face Cradle Pillow and Head Pillow.
3. ComfortSoul MemoryFit™ Face Cradle Pillow: provides your clients with the most comfortable face-down position possible.
4. ComfortSoul PlushFit™ Neck Pillow: provides extra comfort and support for the neck.
5. ComfortSoul PlushFit™ Head Pillow: provides taller clients with head support even beyond the length of the bed.
6. Electronic Multi-Function Hand Remote.

* Default position: Bed completely flat, Lowest height, No attachments

* All heights measured from ground to top

DIRECTIONS FOR ATTACHMENTS

Memory Fit Face Cradle Pillow™

The Memory-Fit Face Cradle Pillow™ takes pressure off sensitive facial areas while providing superb support. The SmoothLock™ Face Cradle can be used in both prone and uprest positioning, and can be removed completely and stored.

COMFORTSOUL SMOOTHLOCK™ FACE CRADLE: PROVIDES SMOOTH AND EASY ADJUSTMENTS FOR FACE CRADLE PILLOW AND HEAD PILLOW.

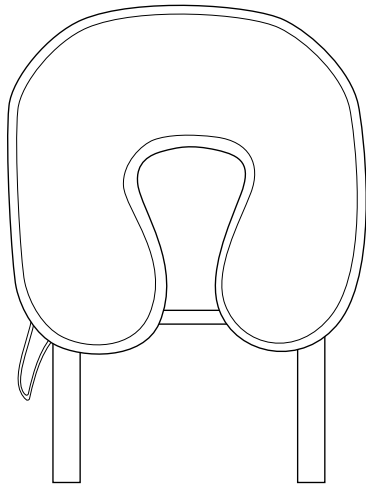

12" x 12" x 2" (L x W x Thickness)

1. To use the Face Cradle, pull SmoothLock™ lever away from the Face Cradle. Slide extension poles into wooden extension holders.



2. Push Face Cradle into extension holders until the bottom of the pad is flush with the top of the chair. Twist SmoothLock™ lever clockwise until lever is hand tightened.



3. Once SmoothLock™ lever is firmly twisted, flip SmoothLock™ lever back towards Face Cradle to lock Face Cradle extensions (reverse step one).

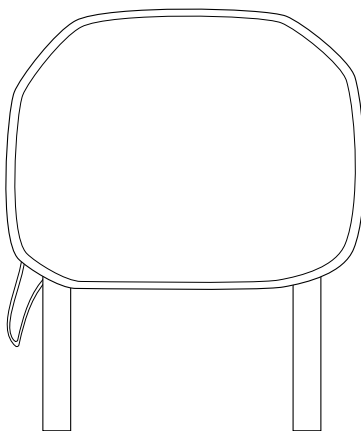

Head Pillow: 16" x 12" x 2"
(L x W x Thickness)



DIRECTIONS FOR ATTACHMENTS

3 FUNCTION HAND REMOTE

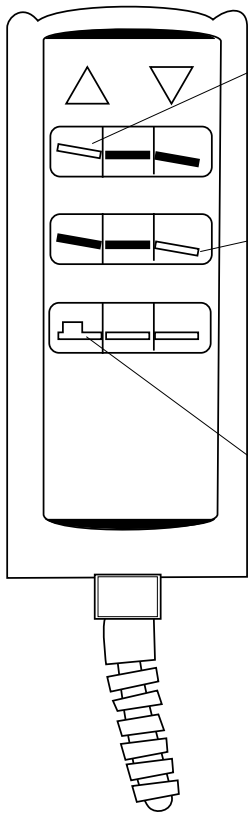

INDEPENDENT ELECTRONIC ADJUSTMENT FOR BACK

INDEPENDENT ELECTRONIC ADJUSTMENT FOR LEGS

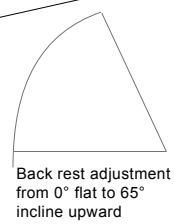

Back rest adjustment from 0° flat to 65° incline upward

Leg rest adjustment from 0° flat to 45° downward decline

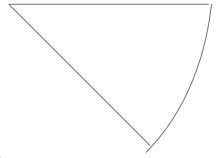

INDEPENDENT ELECTRONIC ADJUSTMENT FOR HEIGHT

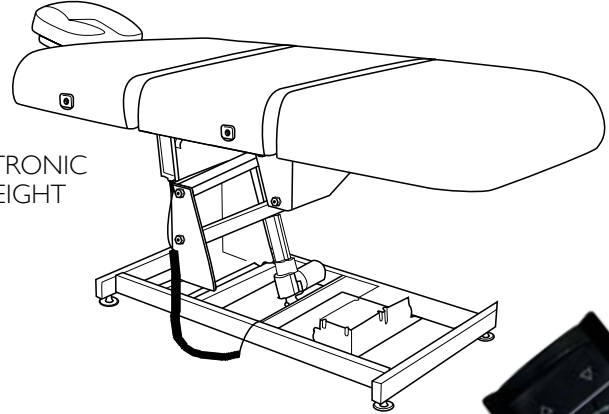

TROUBLE SHOOTING

Caution

The table weighs as much as 250 lbs. Use extreme caution if turning the table on its side. When turning the table on it's side, seek assistance to assure a safe operation.

NOTE:

The new electronic component will be reinstalled in the same manner as the old one. When disassembling please take note of the order, installation method and placement of plugs as the new unit will be reassembled in the same way.

Cable clamp



T-CABLES, ACTUATOR & CABLE CLAMP

Check the outlet to be sure that it has power and that the power cable is plugged in. Try each Hand Remote switch to see if any works. If one works, then possibly there is a loose connection or a faulty controller.

Remove plastic cable clamp, make sure that all male and female connectors are firmly pushed into each other. Even a slight misconnection can cause a possible malfunction.



Check the connections to the T-connector make sure all cables are secure to actuator and plastic clamp is set.



If one or both are still inoperable, then call Customer Service (1-877-266-7685) Option 2 for replacement parts. Proceed to the next step after receiving the replacement.

Caution

*Before doing any work on the unit, disconnect the power cord from the power outlet.

* Be sure to read all cautions, warnings and instructions given in the manual to prevent injury to both operator and client.

TROUBLE SHOOTING

NOTE:

The new electronic component will be reinstalled in the same manner as the old one. When disassembling please take note of the order, installation method and placement of plugs as the new unit will be reassembled in the same way.

REPLACING THE HAND REMOTE

1. The Hand Remote is connected through a friction fit connection to a shielded plug T-Connector that is plugged directly into the Motor Actuator.



2. Remove the Hand Remote plug from T-connector socket by pulling them firmly apart. Grasp the shielded cable plug and the Foot Control plug and work the two apart until fully disconnected.
3. Obtain the new Hand Remote
4. Install the new Hand Remote by connecting the control's plug to the shielded cable plug of the T-Connector and applying pressure

True connection



Poor connection



CARE & CLEANING

HOW TO CARE FOR YOUR UPHOLSTERY:

Upholstery

In order to maintain the quality and ensure the life of the Lumina Elite™, here are some preventative steps that can be taken to protect the upholstery on the table and accessories.

- Protect your table and accessories with sheets and fleeces. We offer both fitted sheets and thick fleeces that protect your upholstery fabric against oil stains while offering comfortable 100% cotton flannel softness to your clients. You can also preserve your face cradle and bolsters with 100% cotton flannel covers and fleeces.
- Clean your upholstered items only when needed with a mild detergent or Green Windex. A diluted 1/100 bleach solution for disinfecting can be used. Dry the table immediately after cleaning to remove excess cleaning solution. Using strong cleaners, such as alcohol, acetone, higher concentrations of bleach or other products that contain high concentrations of these substances, can shorten the life of your fabric, or discolor it. Note: Damage caused by them will not be covered under the warranty.
- Avoid extremes in heat. Very cold temperatures can make your fabric prone to cracking. Very high temperatures can cause the fabric to stretch permanently.
- Avoid exposing your products to direct sunlight for extended periods of time. This can lead to fading and cracking of the fabric.
- Use an anti-slip pad to prevent oil from reaching the upholstery and to keep your sheets from slipping.

GENERAL CARE OF EQUIPMENT COMPONENTS:

Base & Controls

- Use only a mild solution of 4:1 diluted non-alcohol cleaner such as 409®, Fantastik® or some other non-abrasive cleaner to wipe down the metal surfaces of the table. Apply with a damp (not wet) lint-free cloth. Be sure excess liquid does not drip onto, or into, any of the electrical controls or mechanisms. Be sure that the unit is unplugged before cleaning these areas. Wipe these areas carefully with a lint free cloth.
- The electronic powering mechanism of your Lumina Elite™ requires no general maintenance or lubrication.

WARRANTY STATEMENT

MODEL	LUMINA ELITE		
FRAME UNDERSTRUCTURE	UPHOLSTERY PADDING	ELECTRICAL COMPONENTS	SHIPPING
Limited Lifetime Warranty — Original owner; up to 5 years after model is discontinued	2 YEARS	2 YEARS	YES

All warranties are limited to factory-provided replacement parts, factory repair or replacement, at the discretion of COMFORTSOUL®. COMFORTSOUL® only covers parts and labor on field repair of stationary products.

All warranties exclude damage caused by improper set-up, accident, abuse, misuse, neglect, use for other than intended purpose or reasonable wear such as tears in the upholstery.

All warranties are invalidated by non-factory modifications and unauthorized repairs, which will immediately terminate all liability by COMFORTSOUL® for the product or damages caused by its use.

The buyer and its customers shall be responsible for proper set-up and use of the products as well as any supervision required for safety. In no event shall COMFORTSOUL® be liable for any special, indirect, consequential, incidental, exemplary or punitive damages or costs. Use of non-approved cleaning solutions voids the guarantee on all fabrics.

The warranties set forth herein are the sole and exclusive warranties provided by COMFORTSOUL®. There are no other warranties, representations or guarantees provided by COMFORTSOUL® either expressed or implied, including warranties of merchantability and fitness for a particular purpose. Warranty valid with proof of purchase.

CONTACT INFORMATION:

.....

If you have any questions about our products, feel free to contact us via email or by phone. We are available via telephone during PST business hours. We try to respond to emails within a few hours of their receipt, even during evenings and weekends.

.....

General Information:

.....

Email: sales@comfortsoul.com
Fax: 1-800-768-5643

Sales:

.....

Email: sales@comfortsoul.com
Telephone: 1-877-COM-SOUL
(1-877-266-7685) Option 1

Technical Support:

.....

Email: support@comfortsoul.com
Telephone: 1-877-COM-SOUL
(1-877-266-7685) Option 2

Mailing Address:

.....

3350 Wilshire Blvd.
Suite 1210
Los Angeles, CA 90010
USA