



# TAIJI

# universal companies®

## Operating Instructions

### TAIJI HOTCABI HC-12U<sub>V</sub>e Towel Warmer



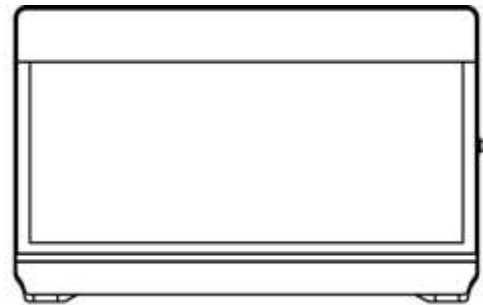

#### Contents:

##### Introduction

1. General description and operating principal
2. Precautions for safety use
3. Names of parts
4. Inspection and preparations before use
5. Safety device and instructions for use
6. After use
7. After-sale service
8. Product specifications
9. Accessories



**Caution: Before attempting to connect or operate this product, please read the label on the bottom.**

<div style="text-align: center;"> <div style="border: 1px solid black; padding: 5px; margin-bottom: 10px;"> <p><b>CAUTION</b></p> <p>RISK OF ELECTRIC SHOCK</p> <p>DO NOT OPEN</p> </div> <div style="display: flex; justify-content: space-around;">   </div> </div>	<p><b>CAUTION:</b></p> <p>TO REDUCE THE RISK OF ELECTRIC SHOCK, DO NOT REMOVE COVER (OR BACK).</p> <p>NO USER SERVICEABLE PARTS INSIDE.</p> <p>REFER SERVICING TO QUALIFIED SERVICE PERSONNEL.</p>
<div style="text-align: center;">  <p>SA 1965</p> </div>	<p>The lightning flash with arrowhead symbol, within an equilateral triangle, is intended to alert the user to the presence of uninsulated “dangerous voltage” within the product’s enclosure that may be of sufficient magnitude to constitute a risk of electric shock to persons.</p>
<div style="text-align: center;">  <p>SA 1966</p> </div>	<p>The exclamation point within an equilateral triangle is intended to alert the user to the presence of important operating and maintenance (servicing) instructions in the literature accompanying the appliance.</p>

The serial number of this product may be found on the bottom of the product. You should note the serial number of this product in the space provided and retain this booklet as a permanent record of your purchase to aid identification in the event of theft.

Model No.: \_\_\_\_\_

Serial No.: \_\_\_\_\_

**WARNING: TO PREVENT FIRE OR ELECTRIC SHOCK HAZARD, DO NOT EXPOSE THIS PRODUCT TO RAIN OR MOISTURE.**

### 1. Introduction:

To use the product correctly and safely, you are advised to carefully read these instructions and fully understand them before use.

Keep this booklet at hand for quick references after reading.

This booklet covers mainly safety precautions, the names of parts, instructions for use, after-sale service, and product specifications.













Failure to observe the precautions given in this booklet may result in death and physical injuries. Do not to use the product in a manner which dose not conform to the instructions given herein.















Specifications and the product are subject to change without any obligation on the part of the manufacture.

### 2. General description and operating principal:

This HOTCABI HC-12Uve towel warmer is designed to keep pre-moistened towels at warm condition for inside use. By a heater and a thermostat installed inside the product, it keeps towels at constant temperature between 158° F (70°C) and 176° F (80°C) when room temperature at 86° F (30°C). GTL-2 2W UV lamp sterilizes inside the cabinet wall surface. Do not use the product for other than intended use. Do not use outdoors.

### 3. Precautions for safety use:

Do not disassemble: 	Do not disassemble, repair nor reform the product unless qualified electric engineer. It may cause unexpected flashing or electric shock.
Connect ground terminal: 	The product is equipped with a power plug with ground terminal. Connect ground terminal firmly. No ground connection or improper connection may cause an electric shock. Do not ground to gas piping or water piping.
No water: 	The product is not water-proof construction. Do not sink the product into water or do not expose water to the product. It may cause an electric shock.
Check and clean 	Check regularly power plug pin points and surface of plug connecting face as no dust. Insert power plug firmly to power outlet. Dust on power plug pin points or surface of plug connecting face or improper connection may cause fires and an electric shock.
Do not damage power cord: 	Do not damage power cord. Do not alter, tug, tie or pressurize power cord. It may destroy inside the power cord and may cause fires and an electric shock. Do not place power cord proximately fire place.
Do not use outdoors. 	Do not use the product outdoors. Rain, snow or fog may cause fires and an electric shock.
Do not leave: 	Please dispose of the product properly. Consult to local dealer or public organization for disposal if necessary. Disposal charge is not any obligation on the part of the manufacture.
Do not put heavy items: 	Do not put heavy items or pressurize on door edge while opened. It may cause door drop and any injuries by the product tumbling.
No humidity: 	Do not place the product at humid place. It may cause an electric shock due to bad electrical insulation and leakage.
Use independent outlet: 	Do not plug in too many leads into a single power outlet. It may cause fires.
Do not bend power plug pins 	Do not bend power plug pins to secure connection to power outlet. It may cause fires due to improper connection.
Pull out the plug with holding: 	When disconnecting power plug, hold the plug, do not pull the power cord. It may cause of deformation of power plug pin points. It may cause fires and an electric shock.

Do not touch with wet-hand: 	Do not touch or operate power plug, power switch and other electrical parts with wet-hand. It may cause an electric shock.
Do not drop 	Do not drop the product or give strong pressure to the product. It may cause mechanical/electrical problems and fires.
Dispose of packing plastic bag immediately: 	Dispose of packing plastic bag immediately after untie the product. To prevent danger of suffocation, keep this plastic bag away from babies and children.
Do not place heavy items 	Do not place heavy items and liquid bottles etc. on the main cabinet. They may cause to scratch and rust surface of the product. Also they may cause an electric shock and other physical injuries by drop or tumbling.
Use towels in polyethylene bag:  	Use pre-moistened towels in polyethylene bag that resists heat minimum 248° F (120°C). Naked towels may dry faster and change the color. In case naked towels are used, squeeze water firmly (approx. 2.5 times weight of dry condition), then insert into polyethylene bag and seal up the opening. Do not use plastic (vinyl) bag as weak heat resistance.
Use basket: 	Keep towels with basket. If not, it may cause towel color change by polyethylene bag melting with heat from inner box surface.
Do not storage too many towels: 	Do not storage too many towels to prevent touching to inner box surface where it may excess over 212° F (100°C). Polyethylene bag may be melted and it cause of changing towel color.
Do not storage longer: 	Do not storage same towel longer: It may cause of changing towel color and occurring smell.
High temperature: 	During operating, inner box surface, basket, door back board are extremely hot. Be careful fingers and hand from burns when putting or removing hot towels.
Remove drain water: 	Remove drain water before overflow. Take off the drain tray by sliding carefully and remove water.
Wipe up water:  	In case no use for more than a day, remove all towels and basket, and wipe up any waterdrop and moisture in the inner box and on the basket. If any waterdrop and moisture in the inner box are left, it may cause to generate bad smell.
Attention required for using: 	This appliance is not intended for use by persons (including children) with reduced physical, sensory or mental capabilities, or lack of experience and knowledge, unless they have been given supervision or instruction concerning use of the appliance by a person responsible for their safety. Children should be supervised to ensure that they do play with the appliance.

#### 4. Names of parts:

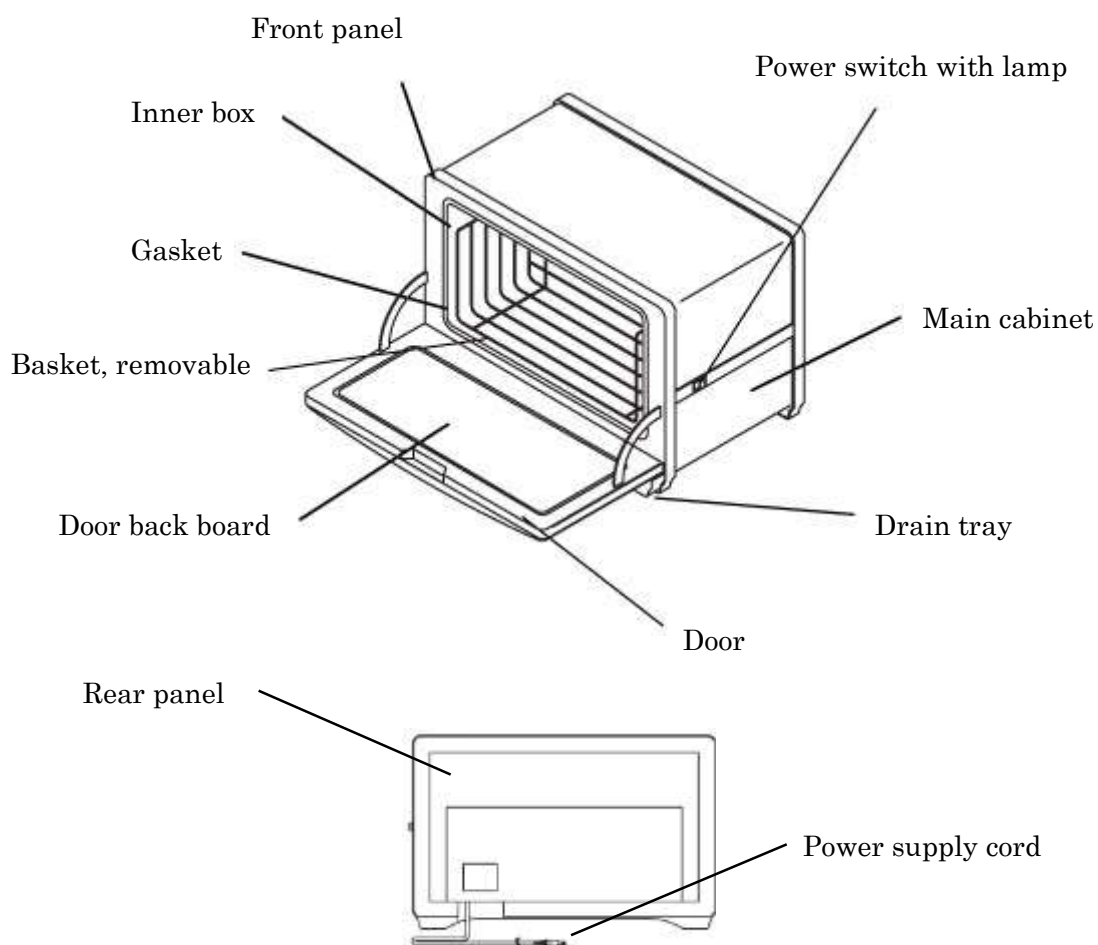

#### 5. Inspection and preparations before use:

Check the operating instructions booklet and standard accessories are accompanied with the product.

Choose a proper place for the product. The place should be stable and flat level, well-ventilated place and away from heat sources, such as gas burner and cooking range, and free from exposure to direct sunlight. Keep the unit at least 2 ft. (60cm) away from them. A place should not so humid, not exposed to water.

Set the product horizontally on suitable places as above.

Set the drain tray horizontally into its hollow under the door.

Use an independent power outlet. Be sure to plug in the power plug to a power outlet of 110-120V AC 15A minimum or 220-240V AC 7.5A minimum, to which nothing else is connected.

The product is cleaned before the shipment. However, when using it for the first time or after a long period of non-use, clean inside of the product.

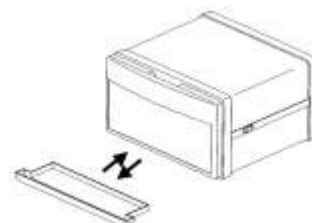

## 6. Safety device and instructions for use:

**SAFELY DEVICE: WHEN THE TEMPERAURE OF THE PRODUCT INSIDE EXCEEDES THE UPPER LIMITS ABNORMALLY BY ANY MEANS, THE THERMAL FUSE BLOWS OUT THE ELECTRIC CIRCUIT. WHEN IT WORKS TURN OFF AND TAKE OFF THE POWER PLUG FROM POWER OUTLET AND CONSULT TO TAIJI PRODUCTS DEALER OR OUR SERVICE FACILITIES.**

Be sure that power switch is "OFF" position.

Connect the power plug to the power outlet. Be sure that power plug must be inserted correctly in position.

Open the door and take off basket.

Place towels on basket, then insert basket with towels into inner box. Do not place towels too many to prevent direct contact to inner box surface.

Close the door firmly.

Turn on the power. Power switch lamp is lit while power is supplied.

UV germicidal light is lit up when switch on the power. UV germicidal light dose not work while the door is opened to protect human being's eyes.

To check UV lamp performance, put magnet to front panel upper left corner where lead switch is installed underneath of the front panel. Do not stare UV light for a long while.

The life of UV lamp is 3,000 hrs. for continuous use under the normal condition. Replace UV lamp every 1-2 years.



### **WARNINGS:**

**TOWELS, STEAM, BASKET AND INSIDE SURFACE ARE HOT AND DANGEROUS. USE EXTREME CAUTION WHEN PUTING OR REMOVING HOT TOWELS OR BASKET FROM THE PRODUCT. ALWAYS USE PROTECTIVE GLOVES WHEN HANDLING HOT TOWELS AND BASKET. CARELESS OR INATTENTIVE HANDLING CAN RESULT IN BURNS OR OTHER SERIOUS PHYSICAL INJURIES.**

## 7. After use:

Turn off the power. Power switch lamp is not lit while power is not supplied.

Take off power plug from power outlet.

After the product is cool down properly remove all towels and basket from inner box.

Wipe up any waterdrop and moisture in the inner box by dry cloth etc.

Wipe up any waterdrop and moisture on the basket.

Take off drain tray by holding two ends of tray corners and pulling the tray forward.

Remove water if necessary.

Clean the product exterior using a dry cloth or damp cloth with mild detergent. Do not use cleansers containing solvents, benzene, abrasives or extremely hot water. (Suggestion: To dry and to prevent smell inner box, leave the door to open for a little while.)

**WARNINGS:**

**PLEASE DO NOT KEEP IN YOUR HOTCABI TOWELS OR OTHER MATERIALS WHICH CONTAIN OR SOAKED WITH OILS OR CHEMICALS. SOME OILS OR CHEMICALS USED IN THERAPIES MAY DAMAGE OR CRACK THE INSIDE OF YOUR HOTCABI OVER TIME IF NOT CLEANED OFF PROPERLY. IF YOU ARE USING SUCH CHEMICALS MAKE IT A RULE TO WIPE ALL PLASTIC PARTS DAILY WITH A SOFT CLOTH SOAKED IN A NEUTRAL DETERGENT SOLUTION DILUTED WITH HOT WATER AND THEN DRY OFF WITH A SOFT CLOTH. PLEASE NOTE THAT THE AREA IN AND AROUND THE DOOR IS ESPECIALLY VULNERABLE.**

8. After-sale service:

For after sales service, call the store where you have purchased your towel warmer, or nearest sales representative. Distributed buy: Universal Companies Info@universalcompanies.com (800)558-5571  
Manufactured by: TAIJI CO. LTD. in JAPAN. FAX № 81-44-329-5860 E-Mail overseas@taiji.co.jp

9. Product specifications:

Circuit diagram

<AC110-120V>

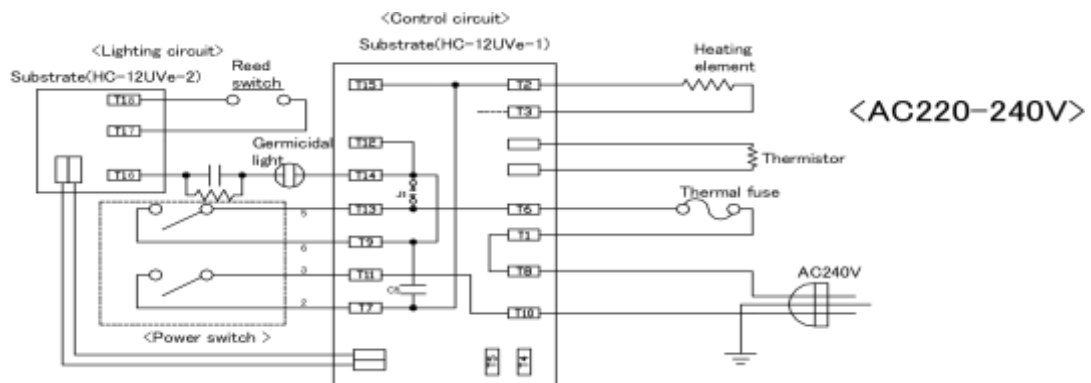
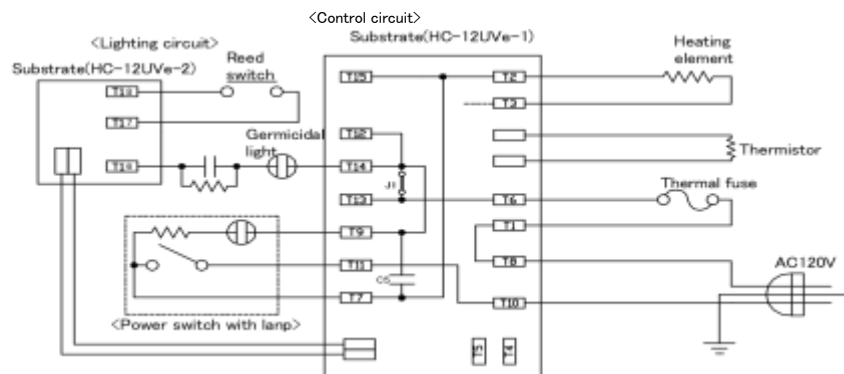

Specifications:

Model No.:	HC-12UVe
Rated power supply:	Single phase 110-120V , 230-240V AC 50/60Hz.
Consumption power:	180-200W
Temp. control:	Electronic control
Inner box temp. range:	158-176° F (70-80°C) at room temp. 86° F (30°C)
Safety device:	Thermal fuse
Insulator:	Glass wool
Outside dimensions:	455(W)x320(D)x290(H)mm 17.9 (W) x 12.6 (D)x 11.4 (H) inch
Inside dimensions:	368(W)x213(D)x170(H)mm 14.5(W)x8.4(D)x 6.7(H) inch
Inner box capacity:	13 liters / 816 in <sup>3</sup>
Weight:	7.5 kg / 28.7 lbs.
Germicidal light	GTL-2 2W

PARTS:

CP509 Taiji Drip Tray Gray  
 CP517 Door Replacement HC-12UVE  
 CP544 Taiji Thermal Fuse Part #50  
 CP545 Front Panel/Taiji HC-12/Gray  
 CP9052T Uv Bulb Replace/Twl Cabi



Universal Companies, Inc.  
 18260 Oak Park Drive  
 Abingdon, VA 24210  
 Phone: 1-800-558-5571  
 Fax: 1-800-237-7199  
 E-Mail: [info@universalcompanies.com](mailto:info@universalcompanies.com)

TAIJI & CO., LTD.  
 8-2, Okawa-cho, Kawasaki-ku, Kawasaki-shi, Kanagawa, 210-0858 Japan  
 TEL 81-44-329-6338  
 FAX 81-44-329-5860  
 E-Mail [overseas@taiji.co.jp](mailto:overseas@taiji.co.jp)  
 Web: <http://www.taiji.co.jp/e>