

INSIGNIA 2.0™



STRATA CLOUDFILL II™ MATTRESS WITH EARTHCONNECT™ GROUNDING & EMF PROTECTION
FLO-TECH II™ ALL-ELECTRIC LIFT SYSTEM • THERMASOFT™ DUAL-ZONE EMBEDDED WARMER



INSIGNIA 2.0™ COLLECTION



INSIGNIA 2.0™ COLLECTION



MODERN™

INSIGNIA 2.0™ COLLECTION



INSIGNIA 2.0™ COLLECTION











CLASSIC™

FEATURED TECH

-  Luxurious Strata Cloudfill™ Mattress with EarthConnect™ Grounding and EMF Protection
-  Flo-Tech II™ all-electric lift system with soft start/soft stop programming powered by Linak®
-  Plug and play actuators
-  Thermasoft™ Dual-Zone Embedded Warmer
-  LED-lit Avonite® in White or Black (Waterfall™ only, custom options available)
-  Convenient wireless hand and foot controls
-  Ample drawer space with simple push opening
-  Comfort-Flex™ upholstery in a variety of spa friendly colors
-  PowerPort™ outlets
-  Hardwood cabinet finish, standard in Natural Maple



CUSTOM OPTIONS

-  Conforma Lux™ Adaptive Chest Comfort System
-  Digital Warming Drawer (enclosed in drawer)
-  ReZen™ Vibro-Acoustic Soundscape. "Unwind the mind" with curated content powered by Myndstream®
-  Clinically tested Mind-Sync™ Restorative Vibrational Wellness reduces stress, anxiety, and promotes sleep
-  GelTech SpaMattress™
-  2 Drawer Option (Standard on Waterfall™)
-  Adjustable, PivotPerfect™ side arms
-  Custom Stains, Lacquers & Fabrics including Ultraleather® & Promessa®

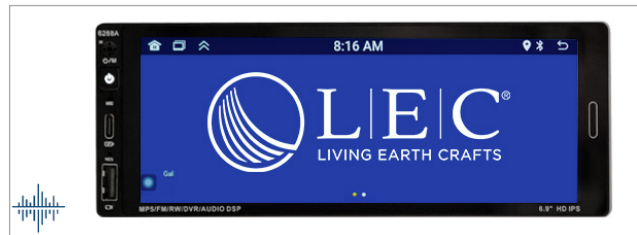
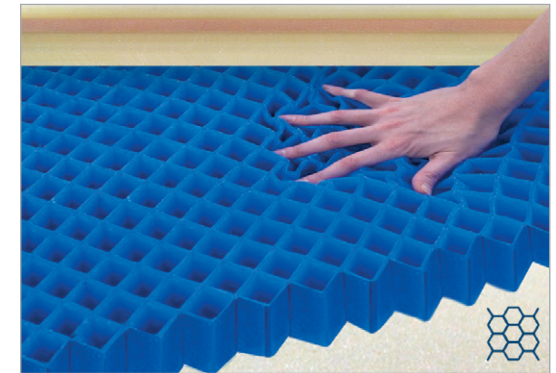

SPECS & DIMS

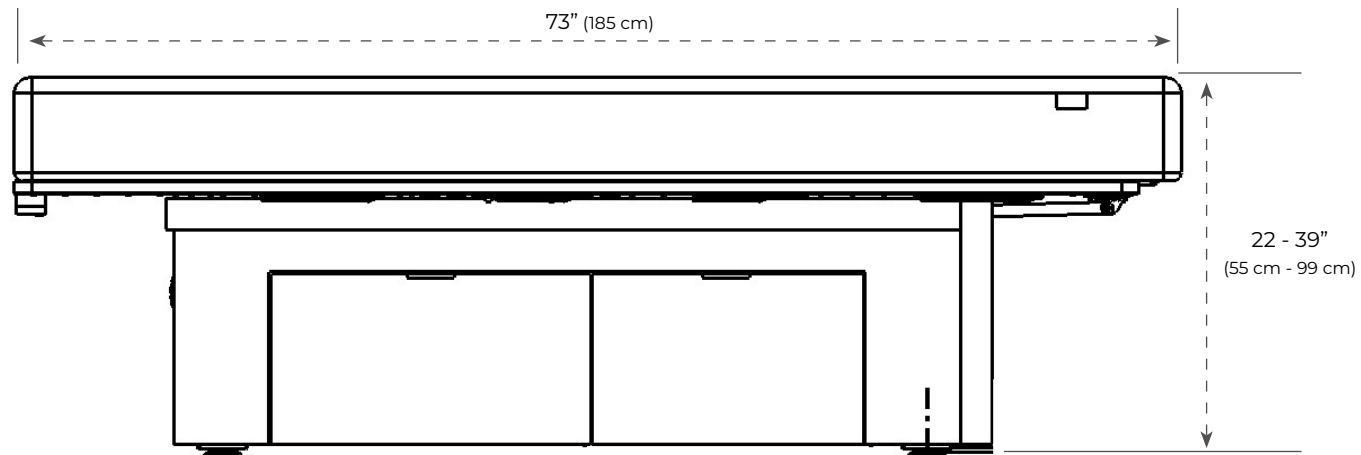
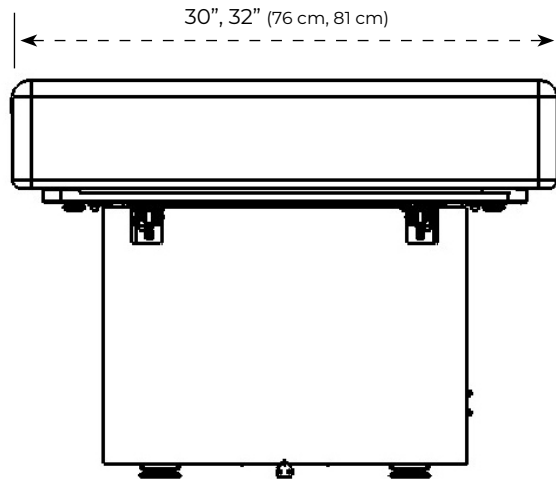

Dimensions

- Width Options: 30", 32" (76 cm, 81 cm)
- Length: 73" (185 cm)
- Height range: 22 - 39" (55 cm - 99 cm)
- Recommended Lift Capacity: 500 lbs. (227 kg.)

Electrical

- 110V / 220V available
- International plug options
- Limited lifetime warranty
-  listed motors & controls | 