

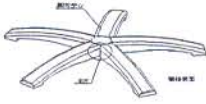





Packing Checklist for RSB-03

Component names	Photo	Qty (pcs)
Star Base		1
Castors		5
Pump		1
Adjustable Plate underneath the seat		1
Seat Pad		1
Back hardware		1
Adjustable Knob		1
Bracket		1
Backrest Pad		1

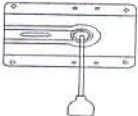
PROSTOOL ASSEMBLY INSTRUCTIONS

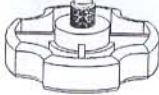

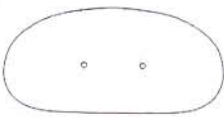
1. Place the star base on floor with wheels touching the floor.

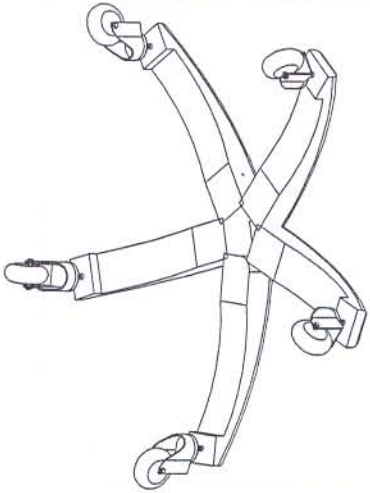

2. Insert the large tapered end of seat cylinder into hole in the center of the star base.

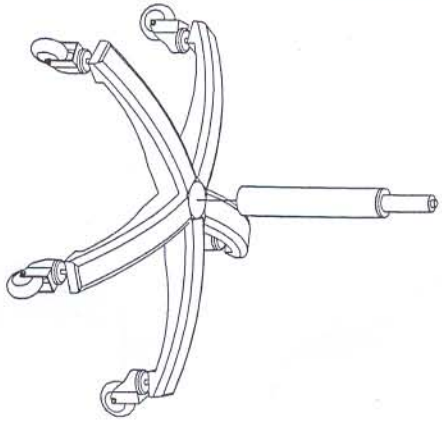

3. Connect hole in center of metal seat plate to top of seat cylinder. Apply pressure to seat to lock together.

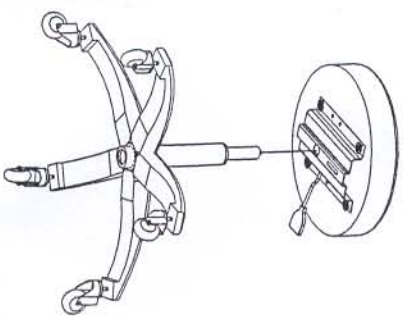

Assembled ProStool

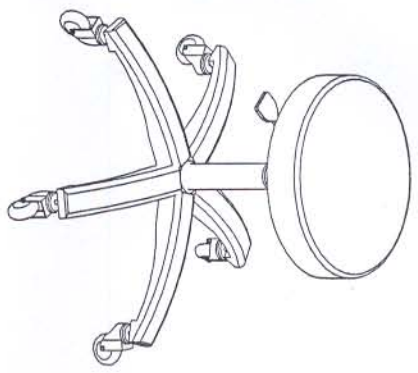

4. To assemble ProStool with Back, insert thicker section of back rest support into slot on metal seat plate.

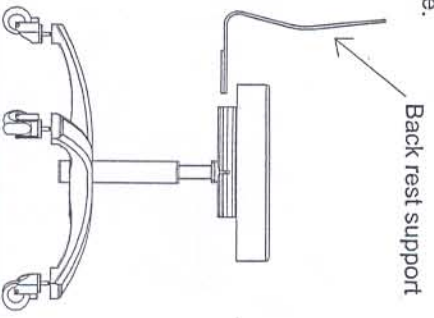

5. Insert screw on plastic knob through slot in back rest support and screw into metal seat plate. Tighten to lock back support.

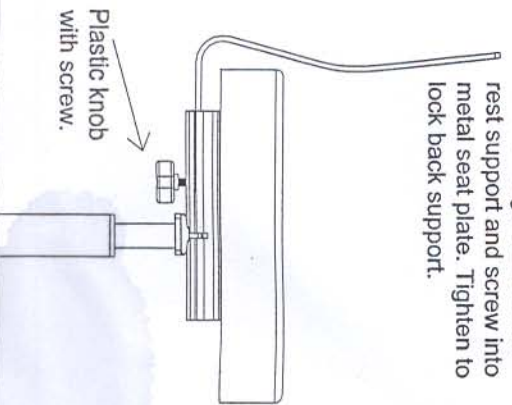

6. Slide back support pad over support rod and adjust to desired height. Screw black plastic knob into metal bracket on back support and tighten knob to lock back support.

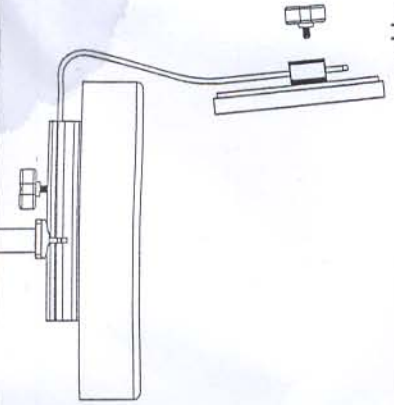

Assembled ProStool with Back

